

Recommendation

T/R 13-02

Preferred channel arrangements for Fixed Service systems in the frequency range 22.0-29.5 GHz

Approved 1993
amended 29 May 2019

RECOMMENDATION T/R 13-02 OF 1993 ON PREFERRED CHANNEL ARRANGEMENTS FOR FIXED SERVICE SYSTEMS IN THE FREQUENCY RANGE 22.0-29.5 GHz, AMENDED 2010 AND AMENDED 29 MAY 2019

“The European Conference of Postal and Telecommunications Administrations,

considering

- a) that CEPT has a long-term objective to harmonise the use of frequencies throughout Europe to benefit from technical and economic advantages;
- b) that CEPT administrations should apply preferred channel arrangements in order to make the most effective and efficient use of the spectrum for fixed service applications;
- c) that in the frequency range 22.0-29.5 GHz three bands are commonly identified for the accommodation of fixed service systems; notably 22.0-23.6 GHz (23 GHz band), 24.5-26.5 GHz (26 GHz band) and 27.5-29.5 GHz (28 GHz band);
- d) that the frequency range 24.25-24.50 GHz may be used by the CEPT administrations at national level for unidirectional links as ENG/OB SAP/SAB;
- e) that, in order to maximise the spectrum resources for fixed service (FS) applications, CEPT administrations may consider to use also the band 22.6-23.0 GHz (23 GHz band centre-gap), for optimising the deployment of unidirectional links such as those for ENG/OB SAP/SAB as well as of bidirectional conventional point-to-point links;
- f) that ECC/DEC/(05)01 introduce a band segmentation between Fixed Satellite Service (FSS) and FS in the frequency band 27.5-29.5 GHz;
- g) that, when very high capacity links are required, it may be achieved by using wider channel bandwidth.

recommends

1. that the fixed service systems in the frequency range 22.0-23.6 GHz should refer to ANNEX 1: and be operated as follows:
 - 1.1. the band 22.0-22.6 GHz paired with 23.0-23.6 GHz should be operated in accordance with the channel plan given in A1.1;
 - 1.2. when CEPT administrations wish to use, within the centre gap of the arrangement in recommend 1.1, the band 22.6-22.75 GHz paired with 22.84-23.0 GHz should select a channel plan in accordance with A1.2;
 - 1.3. when CEPT administrations wish to use the unpaired band 22.75-22.84 GHz in the centre gap of the arrangement in recommend 1.2, a channel plan for unidirectional links should be selected in accordance with A1.3;
2. that the fixed service in the band 24.5-26.5 GHz should be operated in accordance with the channel plan given in ANNEX 2;
3. that the fixed service in the band 27.5-29.5 GHz should be operated in accordance with the channel plan given in ANNEX 3, taking into account ECC/DEC/(05)01;
4. that for the 22.0-23.6 GHz band, CEPT administrations may consider merging any two adjacent 112 MHz channels recommended in A1.1 of ANNEX 1: to create one 224 MHz channel with its centre frequency between the merged channels. To assist cross-border co-ordination, administrations may refer to the channel identifiers described in ANNEX 4;
5. that for the 27.5-29.5 GHz band, CEPT administrations may consider merging any two adjacent 112 MHz channels recommended in ANNEX 3 to create one 224 MHz channel, with its centre frequency between the merged channels. To assist cross-border co-ordination, administrations may refer to the channel identifiers described in ANNEX 5, taking into account ECC/DEC/(05)01.”

Note:

Please check the Office documentation database <https://www.ecodocdb.dk> for the up to date position on the implementation of this and other ECC Recommendations.

ANNEX 1: CHANNEL ARRANGEMENTS IN THE FREQUENCY RANGE 22.0-23.6 GHZ**A1.1 FREQUENCY BANDS 22.0-22.6 GHZ PAIRED WITH 23.0-23.6 GHZ**

Let

F_0 be the reference frequency of 21196 MHz
 F_N be the centre frequency of the radio-frequency channel in the lower half of the band
 F_N' be the centre frequency of the radio-frequency channel in the upper half of the band
 TX/RX separation = 1008 MHz
 Centre gap = 400 MHz

then the frequencies of individual channels are expressed by the following relationships:

a) For systems with a carrier spacing of 112 MHz:

lower half of the band : $F_N = (F_0 + 770 + 112n)$ MHz
 upper half of the band : $F_N' = (F_0 + 1778 + 112n)$ MHz where $n = 1, \dots, 5$

b1) For systems with a carrier spacing of 56 MHz providing 9 channels:

lower half of the band : $F_N = (F_0 + 826 + 56n)$ MHz
 upper half of the band : $F_N' = (F_0 + 1834 + 56n)$ MHz where $n = 1, \dots, 9$

b2) Alternative plan for systems with a carrier spacing of 56 MHz providing 10 channels:

lower half of the band : $F_N = (F_0 + 784 + 56n)$ MHz
 upper half of the band : $F_N' = (F_0 + 1792 + 56n)$ MHz where $n = 1, \dots, 10$

c) For systems with a carrier spacing of 28 MHz:

lower half of the band : $F_N = (F_0 + 798 + 28n)$ MHz
 upper half of the band : $F_N' = (F_0 + 1806 + 28n)$ MHz where $n = 1, \dots, 20$

d) For systems with a carrier spacing of 14 MHz:

lower half of the band : $F_N = (F_0 + 805 + 14n)$ MHz
 upper half of the band : $F_N' = (F_0 + 1813 + 14n)$ MHz where $n = 1, \dots, 41$

e) For systems with a carrier spacing of 7 MHz:

lower half of the band : $F_N = (F_0 + 808.5 + 7n)$ MHz
 upper half of the band : $F_N' = (F_0 + 1816.5 + 7n)$ MHz where $n = 1, \dots, 83$

f) For systems with a carrier spacing of 3.5 MHz:

lower half of the band : $F_N = (F_0 + 805 + 3.5n)$ MHz
 upper half of the band : $F_N' = (F_0 + 1813 + 3.5n)$ MHz where $n = 1, \dots, 168$

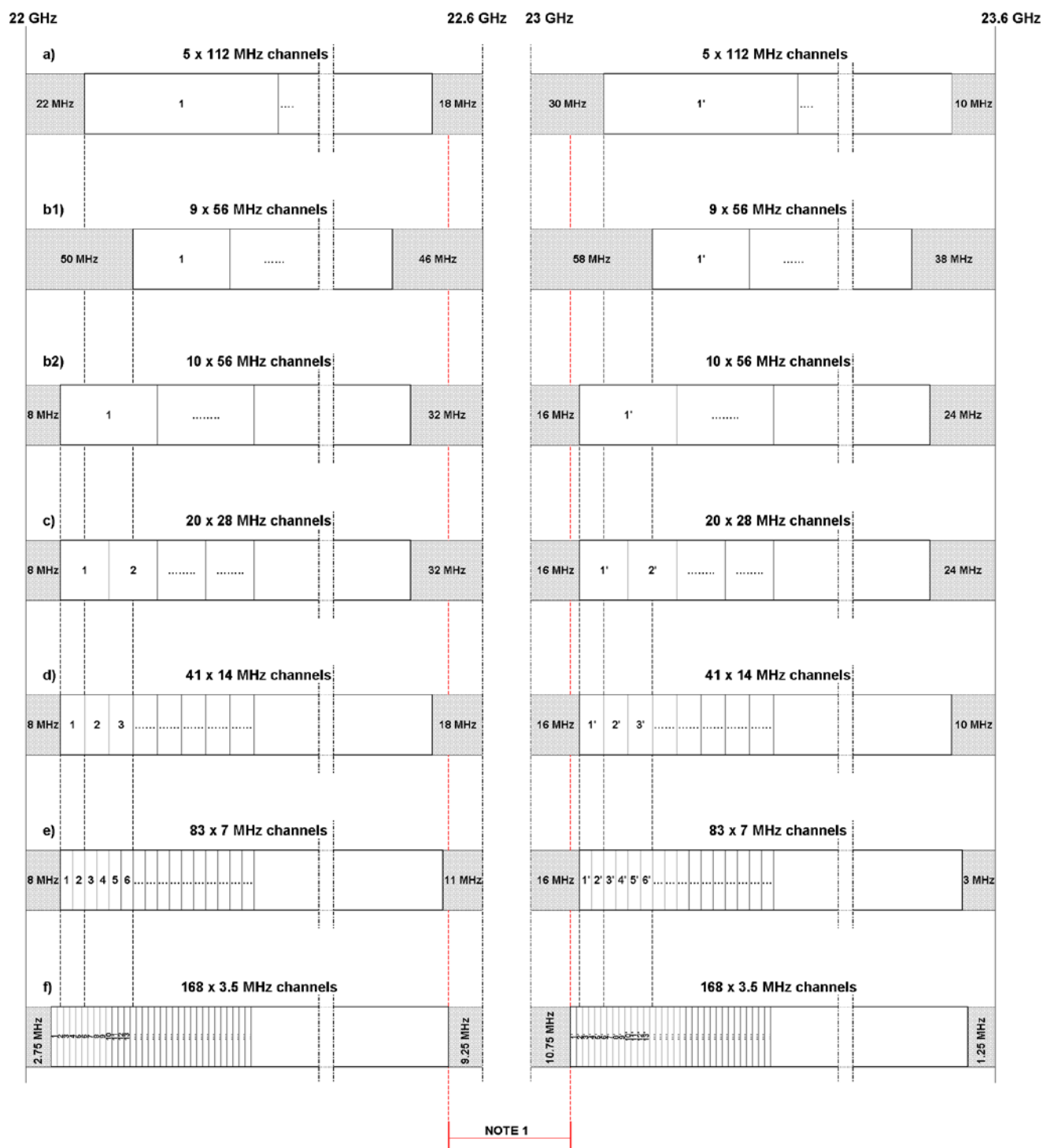

Note 1: For the centre gap channel arrangements see sections A1.2 and A1.3.

Figure 1: Occupied spectrum: 22.0-22.6 GHz / 23-23.6 GHz

A1.2 FREQUENCY BANDS 22.59075-22.75875 PAIRED WITH 22.84275-23.01075 GHZ

These bands are portions of centre gap of the channel arrangement shown in A1.1, combined with the innermost guard bands of the 3.5 MHz arrangement (see Figure 1).

The preferred radio frequency channel arrangement for digital point-to-point fixed wireless systems for carrier spacings of 28 MHz, 14 MHz, 7 MHz and 3.5 MHz should be derived as follows:

Let

F_0 be the reference frequency of 21196 MHz

F_N be the centre frequency of the radio-frequency channel in the lower half of the band

F'_N be the centre frequency of the radio-frequency channel in the upper half of the band

TX/RX separation = 252 MHz

Centre gap = 84 MHz

then the frequencies of individual channels (Note 1) are expressed by the following relationships:

- a) For systems with a carrier spacing of 28 MHz:
- | | | | |
|---------------------|---------------------------------|-----|--------------------------|
| lower half of band: | $F_N = (F_0 + 1380.75 + 28 n)$ | MHz | |
| upper half of band: | $F'_N = (F_0 + 1632.75 + 28 n)$ | MHz | where: $n = 1, \dots, 6$ |
- b) For systems with a carrier spacing of 14 MHz:
- | | | | |
|---------------------|---------------------------------|-----|---------------------------|
| lower half of band: | $F_N = (F_0 + 1387.75 + 14 n)$ | MHz | |
| upper half of band: | $F'_N = (F_0 + 1639.75 + 14 n)$ | MHz | where: $n = 1, \dots, 12$ |
- c) For systems with a carrier spacing of 7 MHz:
- | | | | |
|---------------------|--------------------------------|-----|---------------------------|
| lower half of band: | $F_N = (F_0 + 1391.25 + 7 n)$ | MHz | |
| upper half of band: | $F'_N = (F_0 + 1643.25 + 7 n)$ | MHz | where: $n = 1, \dots, 24$ |
- d) For systems with a carrier spacing of 3.5 MHz:
- | | | | |
|---------------------|-------------------------------|-----|---------------------------|
| lower half of band: | $F_N = (F_0 + 1393 + 3.5 n)$ | MHz | |
| upper half of band: | $F'_N = (F_0 + 1645 + 3.5 n)$ | MHz | where: $n = 1, \dots, 48$ |

Note 1: The channels are shown as paired; however, administrations may envisage unpaired use of those channels according to the national need (e.g. for PMSE). Some administrations may also wish to pair some of the lower channels within the 22.6-23.0 GHz band with the 21.2-21.4 GHz band which is outside the scope of this Recommendation.

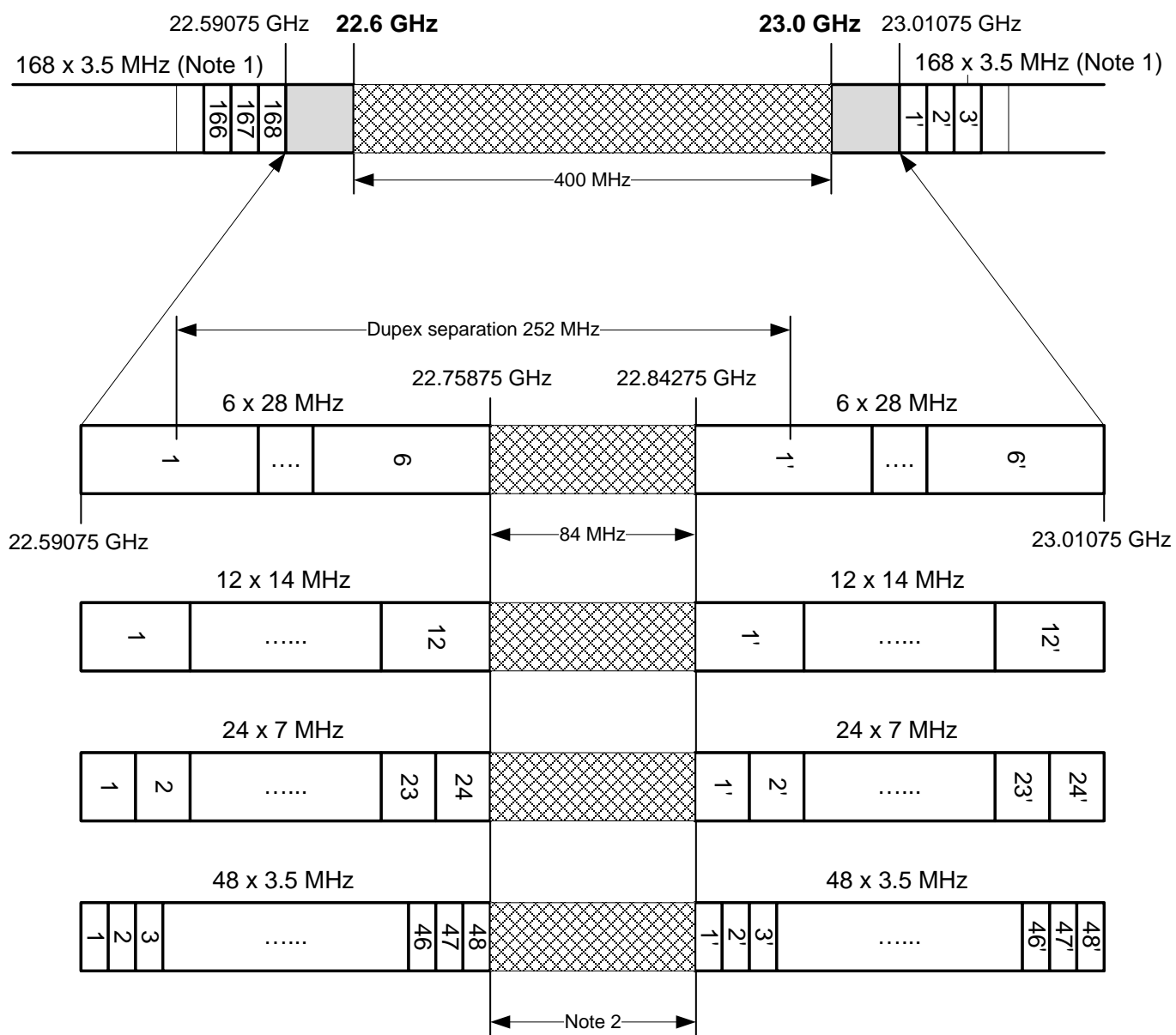

Note 1: This is the 3.5 MHz channel arrangement according section A1.1.

Note 2: For the centre gap channel arrangement see section A1.3.

Figure 2: Occupied spectrum: 22.59075-22.75875 / 22.84275-23.01075 GHz

A1.3 FREQUENCY BAND 22.75875-22.84275 GHZ

This band is the centre gap of the channel arrangement in section A1.2 (see Figure 2), which may be used for unpaired channels.

The preferred radio frequency channel arrangement for digital and analogue point-to-point fixed wireless systems for carrier spacings of 28 MHz, 14 MHz, 7 MHz and 3.5 MHz should be derived as follows:

Let

- F_0 be the reference frequency of 22757 MHz;
 F_N be the centre frequency (MHz) of a radio-frequency channel;

then the frequencies of individual channels are expressed by the following relationships:

- a) For systems with a carrier spacing of 28 MHz:
 $F_N = (F_0 - 12.25 + 28 n)$ MHz where: $n = 1, 2, 3$
- b) For systems with a carrier spacing of 14 MHz:
 $F_N = (F_0 - 5.25 + 14 n)$ MHz where: $n = 1, 2, \dots, 6$
- c) For systems with a carrier spacing of 7 MHz:
 $F_N = (F_0 - 1.75 + 7 n)$ MHz where: $n = 1, 2, \dots, 12$
- d) For systems with a carrier spacing of 3.5 MHz:
 $F_N = (F_0 + 3.5 n)$ MHz where: $n = 1, 2, \dots, 24$

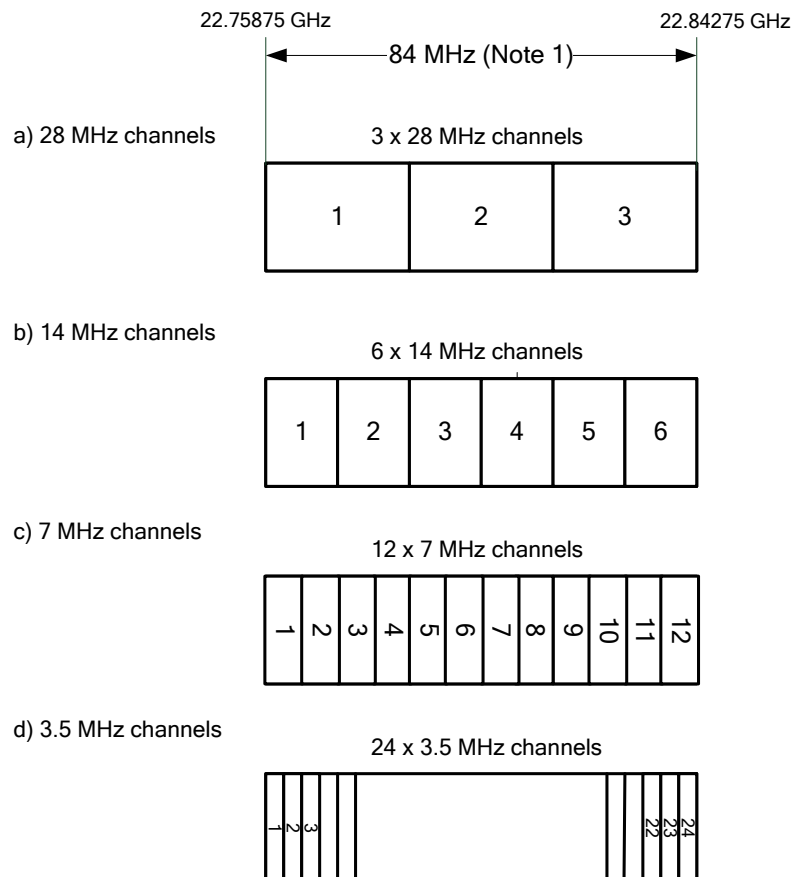

Note 1: This is the centre gap of the channel arrangement in section A1.2 (see Figure 2)

Figure 3: Occupied spectrum: 22.75875-22.84275 GHz

ANNEX 2: FREQUENCY BAND 24.5-26.5 GHZ

Let

F_0 be the reference frequency of 25501.0 MHz

F_N be the centre frequency of the radio-frequency channel in the lower half of the band

F_N' be the centre frequency of the radio-frequency channel in the upper half of the band

TX/RX separation = 1008 MHz

Centre gap = 112 MHz

then the frequencies of individual channels are expressed by the following relationships:

- a) For systems with a carrier spacing of 112 MHz:
- | | | | |
|-------------------------|-----------------------------|-----|-------------------------|
| lower half of the band: | $F_N = (F_0 - 1008 + 112n)$ | MHz | |
| upper half of the band: | $F_N' = (F_0 + 112n)$ | MHz | where $n = 1, \dots, 8$ |
- b) For systems with a carrier spacing of 56 MHz:
- | | | | |
|-------------------------|---------------------------|-----|--------------------------|
| lower half of the band: | $F_N = (F_0 - 980 + 56n)$ | MHz | |
| upper half of the band: | $F_N' = (F_0 + 28 + 56n)$ | MHz | where $n = 1, \dots, 16$ |
- c) For systems with a carrier spacing of 28 MHz:
- | | | | |
|-------------------------|---------------------------|-----|--------------------------|
| lower half of the band: | $F_N = (F_0 - 966 + 28n)$ | MHz | |
| upper half of the band: | $F_N' = (F_0 + 42 + 28n)$ | MHz | where $n = 1, \dots, 32$ |
- d) For systems with a carrier spacing of 14 MHz:
- | | | | |
|-------------------------|---------------------------|-----|--------------------------|
| lower half of the band: | $F_N = (F_0 - 959 + 14n)$ | MHz | |
| upper half of the band: | $F_N' = (F_0 + 49 + 14n)$ | MHz | where $n = 1, \dots, 64$ |
- e) For systems with a carrier spacing of 7 MHz:
- | | | | |
|-------------------------|----------------------------|-----|---------------------------|
| lower half of the band: | $F_N = (F_0 - 955.5 + 7n)$ | MHz | |
| upper half of the band: | $F_N' = (F_0 + 52.5 + 7n)$ | MHz | where $n = 1, \dots, 128$ |
- f) For systems with a carrier spacing of 3.5 MHz:
- | | | | |
|-------------------------|-------------------------------|-----|---------------------------|
| lower half of the band: | $F_N = (F_0 - 953.75 + 3.5n)$ | MHz | |
| upper half of the band: | $F_N' = (F_0 + 54.25 + 3.5n)$ | MHz | where $n = 1, \dots, 256$ |

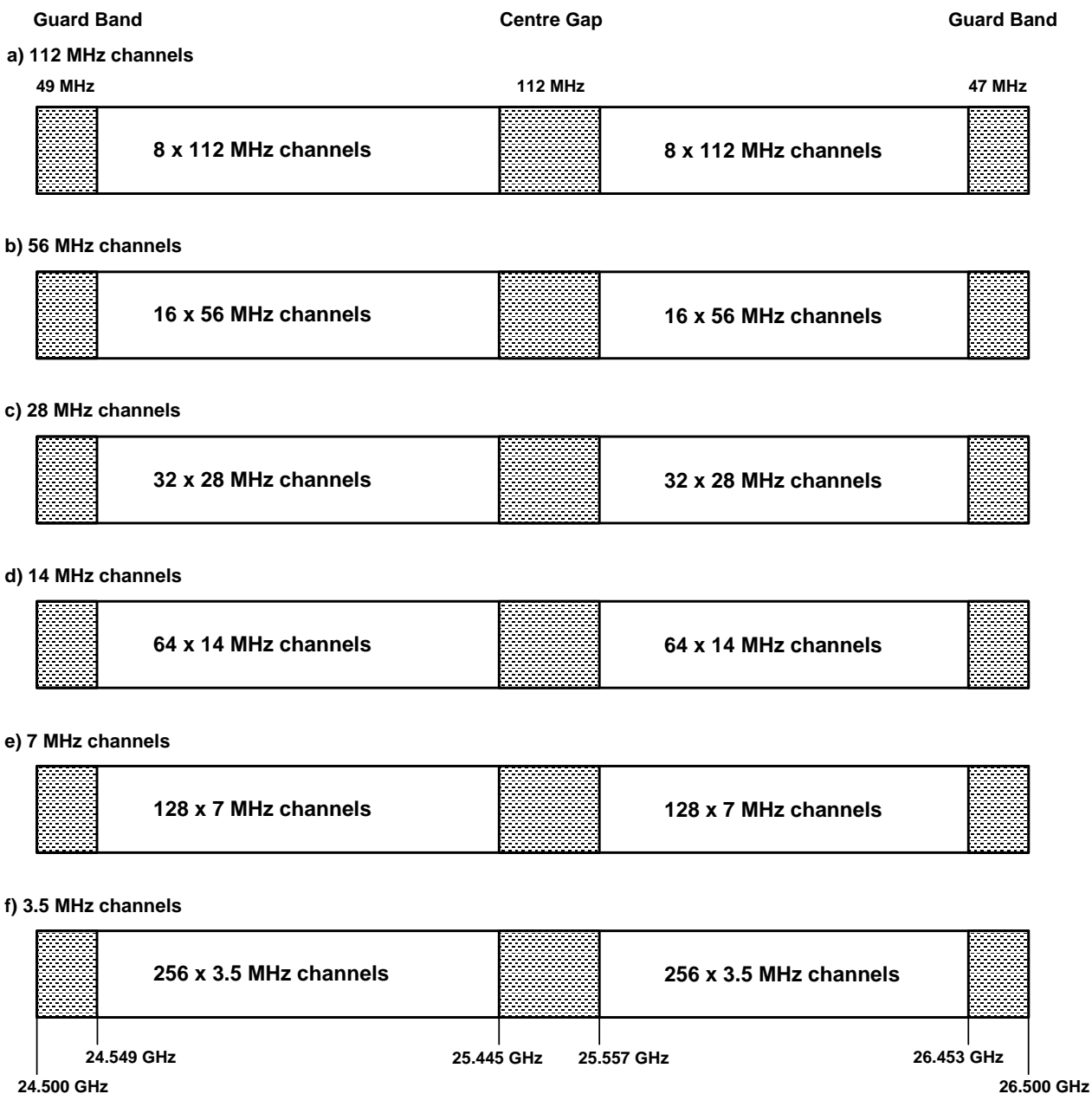

Figure 4: Occupied spectrum: 24.5-26.5 GHz

ANNEX 3: FREQUENCY BAND 27.5-29.5 GHZ

Let

 F_0 be the reference frequency of 28500.5 MHz F_N be the centre frequency of the radio-frequency channel in the lower half of the band F_N' be the centre frequency of the radio-frequency channel in the upper half of the band

TX/RX separation = 1008 MHz

Centre gap = 112 MHz

then the frequencies of individual channels are expressed by the following relationships :

a) For systems with a carrier spacing of 112 MHz:

lower half of the band: $F_N = (F_0 - 1008 + 112n)$ MHzupper half of the band: $F_N' = (F_0 + 112n)$ MHz where $n = 1, \dots, 8$

b) For systems with a carrier spacing of 56 MHz:

lower half of the band: $F_N = (F_0 - 980 + 56n)$ MHzupper half of the band: $F_N' = (F_0 + 28 + 56n)$ MHz where $n = 1, \dots, 16$

c) For systems with a carrier spacing of 28 MHz:

lower half of the band: $F_N = (F_0 - 966 + 28n)$ MHzupper half of the band: $F_N' = (F_0 + 42 + 28n)$ MHz where $n = 1, \dots, 32$

d) For systems with a carrier spacing of 14 MHz:

lower half of the band: $F_N = (F_0 - 959 + 14n)$ MHzupper half of the band: $F_N' = (F_0 + 49 + 14n)$ MHz where $n = 1, \dots, 64$

e) For systems with a carrier spacing of 7 MHz:

lower half of the band: $F_N = (F_0 - 955.5 + 7n)$ MHzupper half of the band: $F_N' = (F_0 + 52.5 + 7n)$ MHz where $n = 1, \dots, 128$

f) For systems with a carrier spacing of 3.5 MHz:

lower half of the band: $F_N = (F_0 - 953.75 + 3.5n)$ MHzupper half of the band: $F_N' = (F_0 + 54.25 + 3.5n)$ MHz where $n = 1, \dots, 256$

Current 28 MHz Channel Arrangement

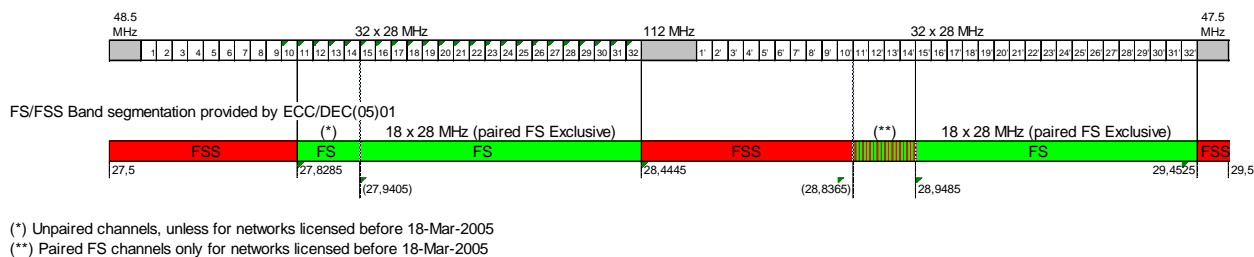

Figure 6: Band segmentation according ECC/DEC/(05)01; 28 MHz channel case

Accordingly the following paired channels (see note) might be unavailable:

- 112 MHz arrangement: channels 1 through 4 paired with 1' through 4'
- 56 MHz arrangement: channels 1 through 7 paired with 1' through 7'
- 28 MHz arrangement: channels 1 through 14 paired with 1' through 14'
- 14 MHz arrangement: channels 1 through 28 paired with 1' through 28'
- 7 MHz arrangement: channels 1 through 56 paired with 1' through 56'
- 3.5 MHz arrangement: channels 1 through 112 paired with 1' through 112'

and the following channels (see note) may remain available only unpaired (for unidirectional links):

- 112 MHz arrangement: channel 4
- 56 MHz arrangement: channels 6 and 7
- 28 MHz arrangement: channels 11 through 14
- 14 MHz arrangement: channels 22 through 28
- 7 MHz arrangement: channels 44 through 56
- 3.5 MHz arrangement: channels 88 through 112

NOTE: For availability of 224 MHz wide channels on the interleaved arrangement see ANNEX 5:

ANNEX 4: CHANNEL ARRANGEMENT AND IDENTIFIERS FOR 224 MHZ CHANNELS IN THE FREQUENCY RANGE 22.0-23.6 GHZ BY MERGING 112 MHZ CHANNELS

The 224 MHz channels (ref. *recommends 4*) can be identified by using the following numbering.

Let

F_0 be the reference frequency of 21196 MHz

F_N be the centre frequency of the radio-frequency channel in the lower half of the band

F'_N be the centre frequency of the radio-frequency channel in the upper half of the band

TX/RX separation = 1008 MHz

Centre gap = 400 MHz

then the frequencies of individual channels are expressed by the following relationships :

lower half of the band : $F_N = (F_0 + 826 + 112n)$ MHz

upper half of the band : $F'_N = (F_0 + 1834 + 112n)$ MHz where $n = 1, \dots, 4$

It is to be noted that the numbering is just for identification of the channelling. It should be noted that two consecutive channel numbers cannot be used on the same physical link due to channels overlap. See figures below for channel arrangement example with identifiers.

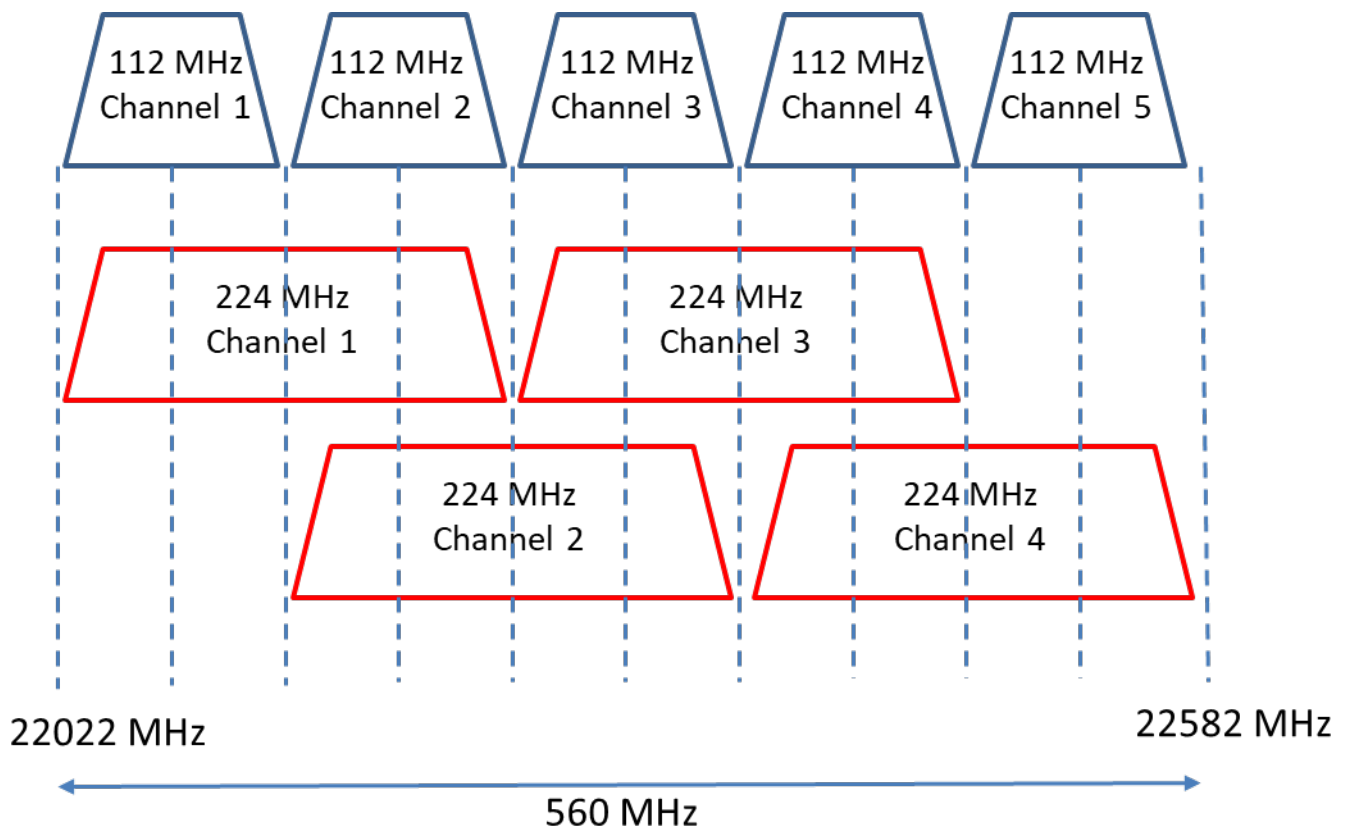

Figure 7: Channel arrangement and identifiers with channel width of 224 MHz (lower half of band)

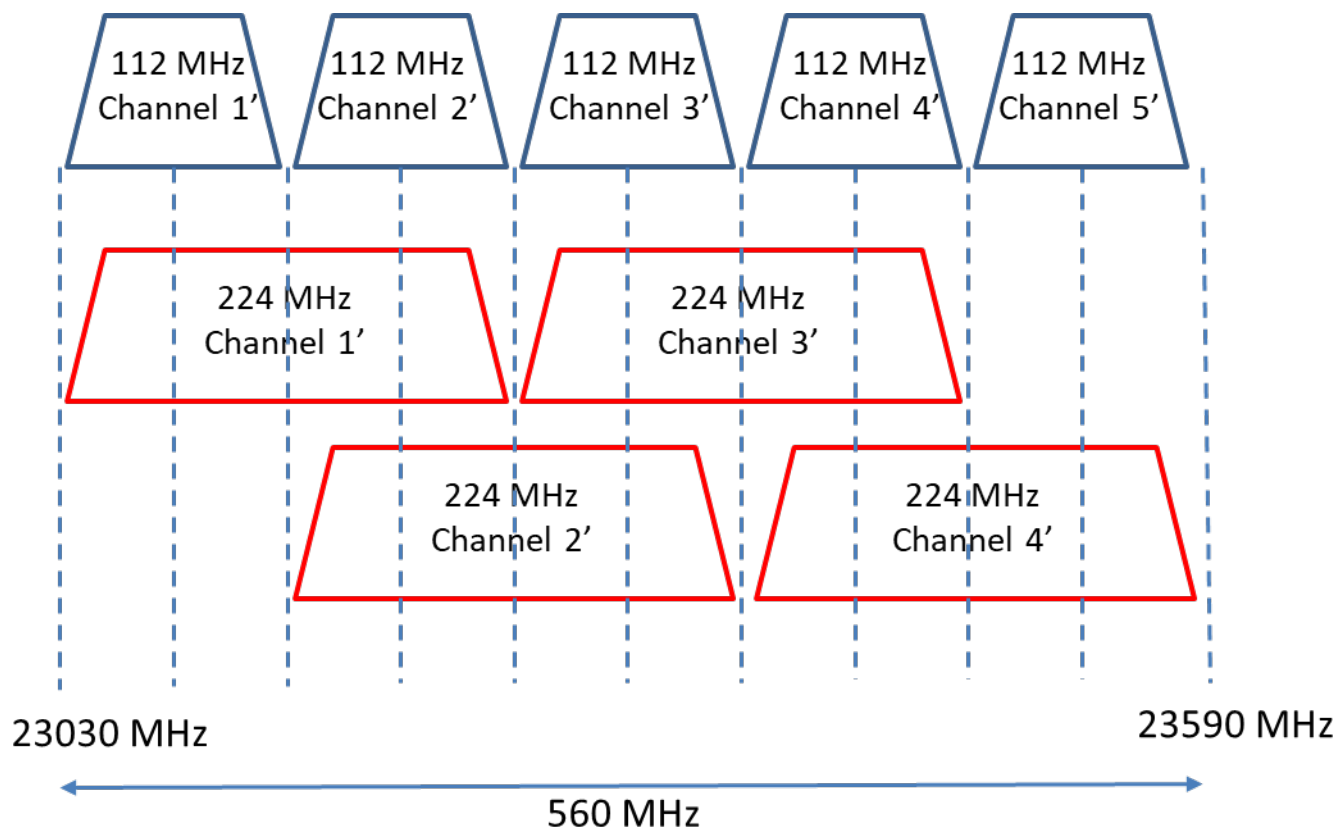

Figure 8: Channel arrangement and identifiers with channel width of 224 MHz (upper half of band)

ANNEX 5: CHANNEL ARRANGEMENT AND IDENTIFIERS FOR 224 MHZ CHANNELS IN THE FREQUENCY RANGE 27.5-29.5 GHZ BY MERGING 112 MHZ CHANNELS

The 224 MHz channels (ref. *recommends 5*) can be identified by using the following numbering:

Let

- F_0 be the reference frequency of 28500.5 MHz
- F_N be the centre frequency of the radio-frequency channel in the lower half of the band
- $F_{N'}$ be the centre frequency of the radio-frequency channel in the upper half of the band
- TX/RX separation = 1008 MHz
- Centre gap = 112 MHz

then the frequencies of individual channels are expressed by the following relationships :

lower half of the band: $F_N = (F_0 - 952 + 112n)$ MHz
 upper half of the band: $F_{N'} = (F_0 + 56 + 112n)$ MHz where $n = 1, \dots, 7$

It is to be noted that the numbering is just for identification of the channelling. It should also be noted that two consecutive channel numbers cannot be used on the same physical link due to channels overlap. See figures below for channel arrangement example with identifiers.

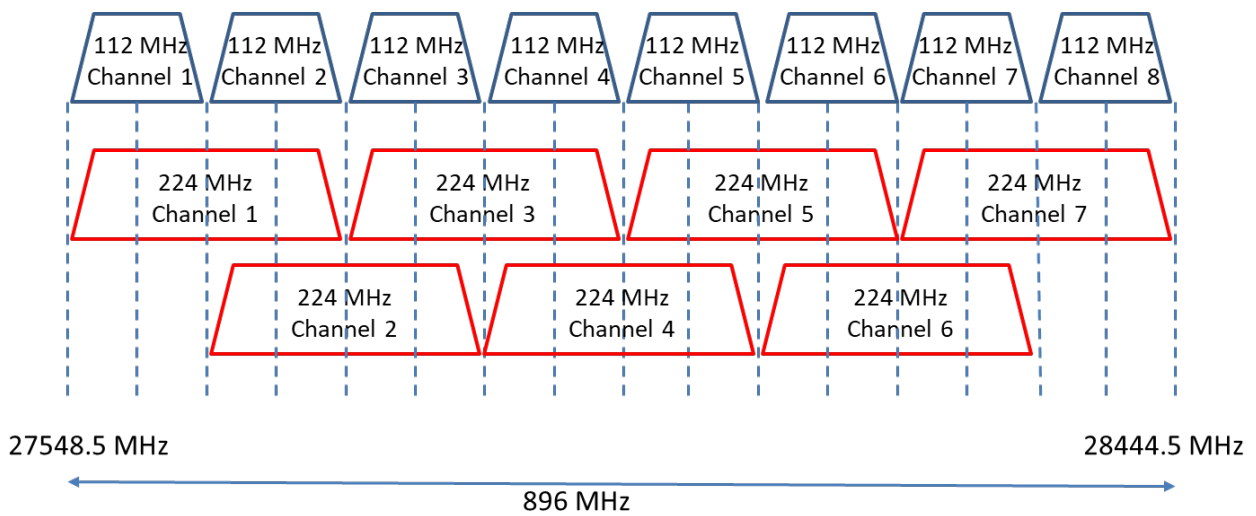

Figure 9: Channel arrangement and identifiers with channel width of 224 MHz (lower half of band) noting that some paired channels might be unavailable (see ANNEX 3:)

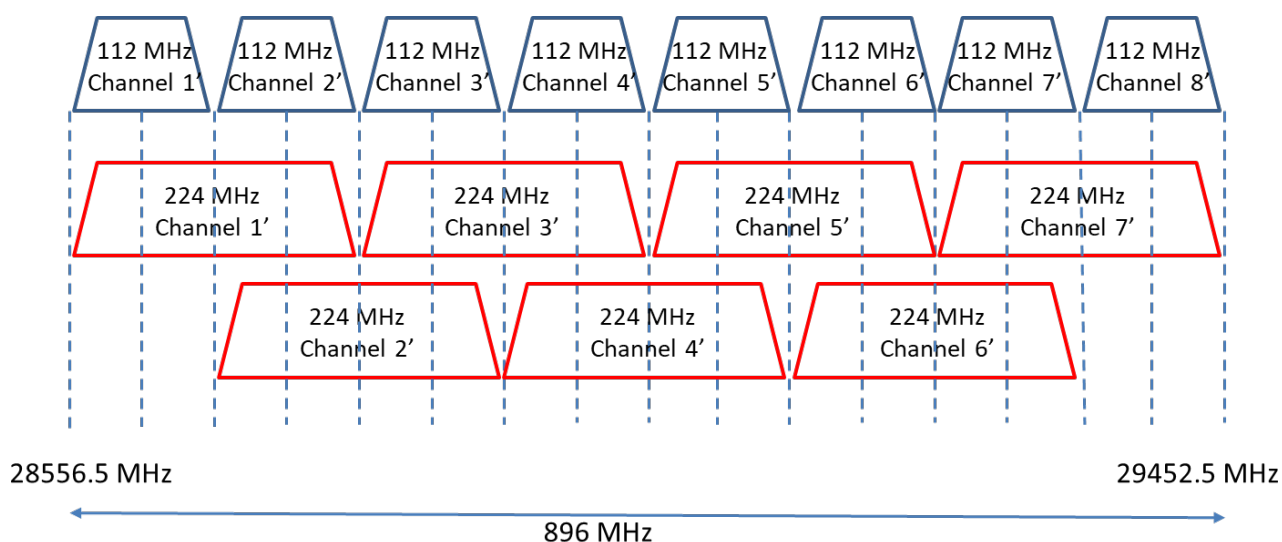

Figure 10: Channel arrangement and identifiers with channel width of 224 MHz (upper half of band) noting that some paired channels might be unavailable (see ANNEX 3:)

In addition, ECC /DEC/(05)01 has defined a band segmentation as sharing condition between FS and FSS in this band; consequently, for those administration that have implemented this Decision, part of the channels described above may no longer be available as shown in Figure 6 of ANNEX 3: for the 28 MHz case.

Therefore, accordingly:

- the 224 MHz paired channels 1 through 4 paired with 1' through 4' might be unavailable
- the 224 MHz channel 4 may remain available only unpaired (for unidirectional links)