



Electronic Communications Committee (ECC)
within the European Conference of Postal and Telecommunications Administrations (CEPT)

**TECHNICAL REQUIREMENTS FOR UWB LDC DEVICES TO ENSURE THE
PROTECTION OF FWA SYSTEMS**

Nicosia, December 2006

Table of contents

1	INTRODUCTION	3
2	VICTIM SERVICES	3
3	DEFINITION OF LDC AND PROPOSED PARAMETER	3
4	UWB REQUIREMENTS AND APPLICATION.....	4
4.1	APPLICATIONS FOR UWB LDC.....	4
5	MEASUREMENT SET UP AND EQUIPMENT DESCRIPTION.....	6
5.1	UWB PROTOTYPE DESCRIPTION.....	6
5.2	FWA EQUIPMENT DESCRIPTION	6
5.3	TEST PROTOCOL.....	7
5.4	THE TEST BENCH.....	8
6	SET OF PARAMETERS USED FOR MEASUREMENTS	8
6.1	SET OF PARAMETERS.....	8
6.2	OTHERS SET OF PARAMETERS FOR UWB LDC (APERIODIC MODE)	9
7	METHODOLOGY AND ACCEPTANCE CRITERIA	9
8	MEASUREMENT RESULTS	9
8.1	VIDEO STREAMING.....	9
8.2	VOIP.....	10
8.3	FTP.....	11
9	ADDITIONAL TESTS.....	12
9.1	IMPACT ON ADAPTIVE MODULATION	12
9.2	IMPACT ON THROUGHPUT AT CELL EDGE	12
9.3	WiMAX TURN-ON SYNCHRONISATION PROCEDURE.....	13
10	CONCLUSION ON MEASUREMENTS	13
11	FURTHER INVESTIGATION NEEDED.....	14
	ANNEX 1: RANGING TECHNICAL REQUIREMENT.....	15
	ANNEX 2: UWB LDC CAPTURED BY THE OSCILLOSCOPE (ILLUSTRATION OF TON/TOFF PARAMETERS)	16
	ANNEX 3: RADIO ENVIRONMENT CHARACTERIZATION	19
	ANNEX 4: IMPACT ON VIDEO SERVICE	22
	ANNEX 5: IMPACT ON VOIP	25
	ANNEX 6: IMPACT ON FTP.....	26
	ANNEX 7: THROUGHPUT AND ADAPTIVE MODULATION.....	29

Technical requirements for UWB LDC devices to ensure the protection of FWA systems

1 INTRODUCTION

Working under EC mandate, CEPT has studied and defined technical requirements for efficient mitigation techniques such as low duty cycle (LDC) in the 3.4 to 4.8GHz band.

At November 2005 ECC TG3 meeting, a contribution submitted by one administration has shown some results based on measurements on efficacy of double-limitation (5% over one second, 0.5% over one hour) for UWB LDC to protect FWA and other systems. ECC TG3 requested however additional measurement campaigns to be performed.

This report has been developed by ECC TG3 for European Conference of Postal and Telecommunications Administrations (CEPT). Two campaigns of measurement have been performed to cover all issues raised by TG3 and dedicated correspondence group. This report presents the results of these measurements campaigns and concludes on technical requirements for UWB LDC devices to ensure the protection of FWA systems.

The technical requirements for UWB LDC devices and the associated new definition presented in this report are proposed to be integrated in the annex of a relevant ECC Deliverable.

2 VICTIM SERVICES

The technical requirement is based on investigation on typical IEEE.802.16 WiMAX system only operating at 3.4 to 4.2GHz band. Therefore other non IEEE 802.16 FWA systems and future possible mobile applications in bands from 3.4 up to 4.2/4.8 GHz should be further investigated.

The band 3.1-3.4 GHz is not considered in the scope of this analysis because it's not allocated to FS or MS. Different constraints might apply to Radiolocation services operating in this band.

3 DEFINITION OF LDC AND PROPOSED PARAMETER

Contributions have clarified the principles and concepts behind LDC set of regulations demonstrating the need to introduce limitations based on burst duration (Ton) and burst intervals (Toff).

ECC Dec (06)04 contain the definition of duty cycle as well as impulse, pulse and burst as reproduced below.

Duty cycle

For the purpose of this Decision the duty cycle is defined as the ratio, expressed as a percentage, of the transmitter sum of all burst duration "on" relative to a given period as specified in the technical requirements.

Impulse, Pulse and Burst

Impulse: a surge of unidirectional polarity that is often used to excite a UWB band limiting filter whose output, when radiated, is a UWB pulse.

Pulse: a radiated short transient UWB signal whose time duration is nominally the reciprocal of its UWB -10 dB bandwidth.

Burst: an emitted signal whose time duration (Ton) is not related to its bandwidth

In line with the technical requirement for LDC, it is proposed to add the following new definition.

Ton

For the purpose of this Decision, the Ton is defined as the duration of a burst irrespective of the number of pulses contained.

Toff

For the purpose of this Decision the Toff is defined as the time interval between two consecutive bursts when the UWB emission is kept idle.

Based on conclusion of the measurement, the following LDC technical requirement is proposed.

Ton max = 5 ms
Toff mean \geq 38 ms (averaged over 1 sec)
 Σ Toff > 950 ms per second
 Σ Ton < 5% per second and 0.5% per hour
PSD max -41.3 dBm/MHz

4 UWB REQUIREMENTS AND APPLICATION

From UWB point of view, LDC restricts the UWB operation mostly to low duty cycle (LDC) applications, although short time communications type of operation is also possible. Concerns were expressed that LDC applications could be predominantly communications and could be located very close to victim terminals. However, it was indicated that some LDC application such as M2M applications (monitoring sensors, object/person location tracking devices either for home automation or industrial/working sites) would not be generally located in close proximity to victim terminals.

As a result of discussions in the IEEE 802.15.4a group, it appears that some targeted UWB applications, such as accurate ranging, instantaneously need some minimum Ton and a very short Toff. This is further explained in Annex 1.

4.1 Applications for UWB LDC

UWB applications are mainly foreseen to be focused on sensor network in home, office or industrial environment. Compared to existing wireless technologies already addressing this market (like IEEE 802.15.4-2003 – ZigBee), the main added value is the support for accurate indoor geolocalisation.

The following table is an attempt to give some usage applications of UWB-LDC with a view of evaluating the associated duty cycles and activity factors.

UWB LDC equipments can be split into two categories:

- Fixed nodes : A very limited number of nodes in a sensor network will be "Anchor" to serve as a reference for geo-localisation and "Access point" for collecting data and coordinating the network. As those nodes will probably be wall mounted and fixed (an anchor is a reference for localisation and so can not be moved in the room), it is very unlikely that such a transceiver will get close (< 1m) of a laptop computer, PDA or other FWA enabled devices.

Domain	Application	Duty cycle δ	Activity factor (AF)	Comments/Other elements
Home / Office	Monitoring sensors (for temperature, luminosity, detection of water leak from a machine, warning for plants watering,...)	Transmission of data only when the monitored event occurs + 1ms/min in any case for showing up	Activity linked to an event \rightarrow very low activity factor ($\ll 0.1\%$)	Need for a home-automation gateway and sensors on the objects.
	Pure home automation Remote control applications such as closing blinds or a portal when detection of corresponding parameters occurs	Transmission of data only when the monitored event occurs + 1ms/min in any case for showing up	Activity linked to an event \rightarrow very low activity factor ($\ll 0.1\%$)	Need for a home-automation gateway and sensors on the objects or persons.
	Real-time location-tracking * switching on the lights when a person enters the room * baby-monitoring with alarm when approaching "dangerous" areas	e.g. baby-monitoring : location-sensing twice/second, 2ms/evaluation = 4ms/s $\rightarrow \delta = 0,4\%$	For baby-monitoring example, no more than 6 hours per day AF = $0,25 * 0,004 = 0,1\%$	Fixed beacons around the rooms where the baby can go, predetermination of areas considered as dangerous.
Industrial	Location-tracking * Follow-up of objects in a production line * location of working-teams on an industrial site (indoor) in order to contact the nearest one in case of urgent action required * logistics management on an industrial site (indoor/)	e.g. follow-up of objects in a production-line : regular transmissions of dynamic information from the object (status, location) 2ms-transmissions each second $\rightarrow \delta = 0,2\%$	10 hours per day AF = $0,4 * 0,002 = 0,08\%$	
	Industrial sensors	Short-data transmissions in the order of 1ms each second $\rightarrow \delta = 0,1\%$	24 hours per day for a non-stop production factory AF = $1 * 0,001 = 0,1\%$	

- Mobile nodes : They are tags attached to an asset, person or system to be tracked or monitored. Those transceivers are self-powered and must keep their activity as low as possible in order to maximise battery life.

5 MEASUREMENT SET UP AND EQUIPMENT DESCRIPTION

In this section, a UWB prototype and FWA equipments are used. The system is transmitting at a level of -41.3dBm/MHz during activity period, and it is not the average power during Ton + Toff (max hold mode measurements)

5.1 UWB prototype description

The UWB LDC equipment used is a prototype developed by FT R&D and, composed of a transmitter built of discrete elements, driven by an FPGA.

It is an UWB-Impulse Radio prototype, with Time Hopping (TH) coding for inter-piconets isolation and smoothing of the spectrum mask. The emitted signal consists of a sequence of 1ns pulses, with a mean periodicity of 160ns. This corresponds to a mean PRF (Pulse Repetition Frequency) of 6.25MHz.

A symbol is composed of 8 frames, hence the symbol duration is 1280ns. Both silence duration between bursts and burst duration can be modified and adjusted for the purpose of the test.

The UWB antennas have been developed by FT R&D and are printed planar antennas with a 60° aperture and 2 dBi gain.

5.2 FWA equipment description

The FWA equipment used in these measurements is an Alvarion (BreezeMax WiMAX) with TPC and adaptive modulation: 64QAM 3/4, 64QAM 2/3, 16QAM 3/4, 16QAM 1/2, QPSK 3/4, QPSK 1/2, BPSK 3/4, BPSK 1/2. For the purpose of the measurements, adaptive modulation scheme has been enabled. Uplink central frequency is 3476.5 MHz and Downlink central frequency is 3576.5 MHz

Table 1-5: Radio Specifications					
Item	Description				
Output Power (at antenna port)	AU-ODU	28dBm +/-1dB maximum. Power control range: 15dB 18-28dBm @ +/-1dB, 13-18dBm @ +/-2dB			
	SU-ODU	20dBm +/-1dB maximum, ATPC Dynamic range: 40 dB			
Modulation	OFDM modulation, 256 FFT points; BPSK, QPSK, QAM16, QAM64				
FEC	Convolutional Coding: 1/2, 2/3, 3/4				
Bit Rate and Typical Sensitivity (PER=1%)	Channel Spacing	3.5MHz bandwidth		1.75MHz bandwidth	
	Modulation & Coding	Net Phy Bit rate (Mbps)	Sensitivity (dBm)	Net Phy Bit rate (Mbps)	Sensitivity (dBm)
	BPSK 1/2	1.41	-100	0.71	-103
	BPSK 3/4	2.12	-98	1.06	-101
	QPSK 1/2	2.82	-97	1.41	-100
	QPSK 3/4	4.23	-94	2.12	-97
	QAM16 1/2	5.64	-91	2.82	-94
	QAM16 3/4	8.47	-88	4.24	-91
	QAM64 2/3	11.29	-83.0	5.65	-86
	QAM64 3/4	12.71	-82.0	6.35	-85

5.3 Test protocol

The measurement set up includes the following components:

- One UWB transmitter as reference transmitter without implementing LDC limitation
 - Freescale DS-CDMA transmitter associated with two Motorola antennas or the UWB prototype described above associated with an antenna (60° aperture) and an attenuator, continuous transmission, with no gating
 - One (+5 VDC ; + 7 VDC) power supply

This is only used on the adaptive modulation test.

- One WiMAX link

With a transmitting part composed of:

- one macro base station, linked to the AU (transmitting part) and to the SmartBits equipment;
- one AU coupled with an fixed attenuators 20 dB plus one variable attenuator, linked to a Huber-Suhner antenna (1.7 to 5.8 GHz, gain +9 dBi);
- one PC to provide Rx level and SU SNR parameters

And a receiving part composed of:

- a Huber-Suhner antenna (1.7 to 5.8 GHz, gain +9 dBi), situated at 0.5, 1, 2 and 4 meters from the UWB antenna and linked to the receiver (SU), linked to the Smartbits via the IDU. The other Smartbits entry is linked to the transmitting microstation;
- a PC linked to the SmartBits equipment that provides the throughput for each modulation.

• Other equipment

- one HP 8596E spectrum analyser (9kHz to 12.8 GHz)
- one Tektronix 12 GHz digital oscilloscope
- one Netcom standardised SmartBits equipment
- various cables, connector N / SMA etc ...

5.4 The test bench

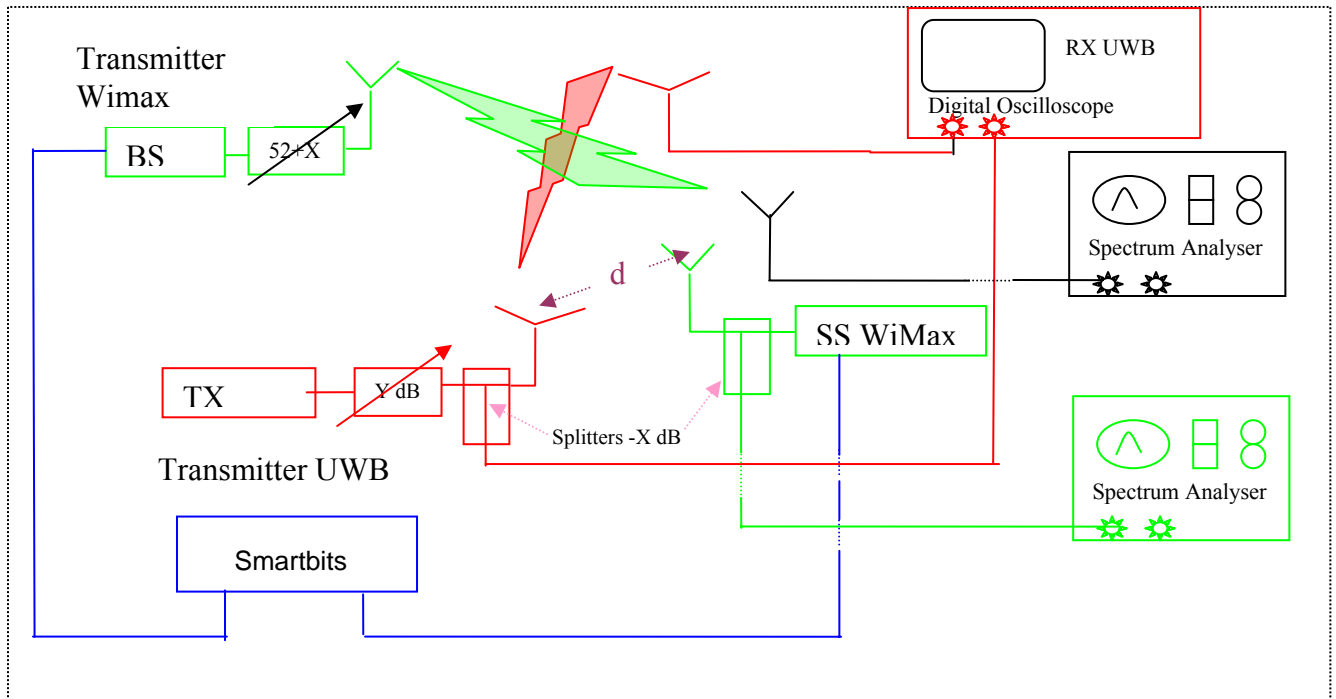

6 SET OF PARAMETERS USED FOR MEASUREMENTS

6.1 Set of parameters

The table presents a set of parameter for UWB LDC used during the measurement campaign. An illustration of the signal capture representing some of these parameters is contained in Annex 2.

Activity factor	Ton (ms)	Toff (ms)
2 %	0.75	38
	5	245
	10	490
5 %	2	38
	5	95
	10	190
10 %	2	18
	5	45
	10	90

6.2 Others set of parameters for UWB LDC (aperiodic mode)

An additional set of parameters for UWB LDC, concentrating all activity at the beginning of each second, has been tested to show those limitations of activity 5% over 1 second for other configurations which could be used and analysed as shown in the Table below. An illustration of the signal capture representing some of these parameters is contained in Annex 2. (Figure A2.3, A2.4 and A2.5)

.Nb is the number of Ton/Toff sequence contained in the burst.

Activity factor	Nb *(Ton/Toff) in ms
Activity Factor 2%	40*(0.5/0.25)
Activity Factor 5%	100*(0.5/0.25)
Activity Factor 7,5%	150*(0.5/0.25)
Activity Factor 10%	200*(0.5/0.25)

7 METHODOLOGY AND ACCEPTANCE CRITERIA

The impact of UWB with LDC limitation on FWA system is measured on different realistic services and applications. The considered services are:

- Video streaming
- VoIP
- FTP

For each service, the same general methodology used is described below

- Set the WiMax received signal strength at equipment minimum sensitivity level, eg. RSSI of -98 dBm
- Get a reference measurement without UWB (depending on each test case)
- Measure the impact with UWB LDC emission (for any considered AF and distances)

Service	Monitored data	Acceptance Criteria
Video	RSSI when frozen pictures appear	RSSI at 1dB degradation compared to RSSI without UWB at 1m distance
VoIP	Downlink MOS note	10 % degradation of reference MOS
FTP	File transfer duration	10 % increase of time duration compared to without UWB LDC

8 MEASUREMENT RESULTS

8.1 Video streaming

A WiMax link with Video streaming has been established between a Windows 2000 Video Server and a Windows Media Player client. The video streaming bit rate is 1 MB/s (640x480) and the video sample is 90 second long.

The configuration for tests is to place UWB LDC at 0.5, 2m and 4m from WiMax downlink antenna. The Figures in Annex 4 illustrate the impact of LDC UWB emissions for the video service, given that the WiMax received signal strength (RSSI) might be increased to compensate the UWB interference.

Degradation (dB)		Distance (m)			
AF (Ton/Toff ms)		0.5	1	2	4
2%	0.75/38	1	N/A	1	N/A
	5/245	0	N/A	0	N/A
	10/490	1	N/A	1	N/A
	Aperiodic mode	0	N/A	N/A	N/A
5%	2/38	2	1	0	N/A
	5/95	1	N/A	1	N/A
	10/190	0	N/A	1	N/A
	Aperiodic mode	0	N/A	N/A	N/A
10%	2/18	3	N/A	0	0
	5/45	3	2	0	0
	10/90	2	N/A	1	0.5
	Aperiodic mode	0	N/A	1	N/A

8.2 VoIP

A link with VoIP service has been established between the WiMax AU and SU with software IxChariot which enables to assess the uplink and downlink transfer characteristics (QoS). This Software IxChariot (Ixia) is widely used to verify quality of VoIP services. It is based on the E-model calculation (G.107). The objective of this model is to determine a quality rating that incorporated the "mouth to ear" characteristics of a speech path. IxChariot calculates a R-value which is correlated directly with a note called MOS for Mean Opinion Score. The equivalence between R factor (Model E) and MOS score is given as following:

User Opinion	R Factor	MOS Score
Maximum obtainable for G.711	93	4.4
Very satisfied	90-100	4.3-5.0
Satisfied	80-90	4.0-4.3
Some users satisfied	70-80	3.6-4.0
Many users dissatisfied	60-70	3.1-3.6
Nearly all users dissatisfied	50-60	2.6-3.1
Not recommended	0 – 50	1.0-2.6

Two codec have been performed in VoIP service:
G 711: data rate is 64 Kbps , frame interval is 20ms
G 729: data rate is 8 Kbps frame interval is 30ms

This table show results for VoIP measure, done with a RSSI = -98 dBm with the G711 codec. The values in bracket are MOS value obtained without UWB.

MOS G711 (w/o UWB)		Distance (m)		
AF (Ton/Toff ms)		0.5	2	4
2%	0.75/38	4.05 (4.21)	4.32 (4.35)	N/A
	5/245	4.3 (4.32)	4.32 (4.37)	N/A
	10/490	4.02 (4.05)	4.31 (4.33)	N/A
5%	2/38	4.33 (4.25)	4.33 (4.38)	N/A
	5/95	4.36 (4.33)	4.36 (4.37)	N/A
	10/190	4.35 (4.33)	4.35 (4.36)	N/A
10%	2/18	4.28 (4.33)	4.33 (4.31)	N/A
	5/45	4.28 (4.30)	4.23 (4.38)	N/A
	10/90	4.31 (4.31)	4.31 (4.38)	N/A

This table show results for VoIP measure, done with a RSSI = -98 dBm with the G729 codec

MOS G729 (w/o UWB)		Distance (m)		
AF (Ton/Toff ms)		0.5	2	4
2%	0.75/38	4.05 (4.03)	4.03 (4.03)	N/A
	5/245	4.02 (4.02)	4.03 (4.02)	N/A
	10/490	4.01 (4.01)	4.02 (4.02)	N/A
5%	2/38	4.02 (4.03)	4.03 (4.03)	N/A
	5/95	4.02 (4.03)	4.03 (4.01)	N/A
	10/190	4.02(4.03)	4.03 (4.03)	N/A
10%	2/18	4.02 (4.03)	4.04 (4.04)	N/A
	5/45	4.00 (4.01)	4.02 (4.02)	N/A
	10/90	4.02 (4.03)	4.03 (4.02)	N/A

8.3 FTP

A link with FTP service has been established (IIS FTP server and command line FTP client), which permits an evaluation of the transmission duration and data rate. The test is based on transmitting a 4 Mbytes file and measuring the transmission duration. For each configuration (AF and distance) this test is repeated seven times in order to compute an average duration (to alleviate measurement dispersion, as can be seen on recorded command lines in Annex 6)

The configuration for tests is to place UWB LDC at 0.5 and 2 m from WiMax Downlink antenna.

This table show average transfer duration of a 4 MB file over a WiMax link. The values in bracket are those transfer time duration obtained without UWB.

Transfer duration (sec)		Distance (m)		
AF (Ton/Toff ms)		0.5	2	4
2%	0.75/38	24 (23.36)	24.57 (24.36)	N/A
	5/245	24.32 (24.36)	24.63 (24.36)	N/A
	10/490	23.78 (24.36)	23.93 (24.36)	N/A
5%	2/38	22.53 (21.53)	24.28 (21.53)	N/A
	5/95	24.85 (21.53)	24.85 (21.53)	N/A
	10/190	24.07 (21.53)	24.18 (21.53)	N/A
	Aperiodic mode	25.6 (23.58)	N/A	N/A
10%	2/18	25.3 (21.53)	24.35 (21.53)	N/A
	5/45	20.58 (21.53)	24.59 (21.53)	N/A
	10/90	24.6 (21.53)	24.66 (21.53)	N/A

9 ADDITIONAL TESTS

9.1 Impact on Adaptive modulation

This measurement presents how adaptive modulation reacts during transmission of a 11 Mb/s bits stream with respect to WiMax link attenuation variation. It appears that there is very limited influence on this mechanism in presence of UWB equipment. Adaptive modulation is working properly with every tested configuration.

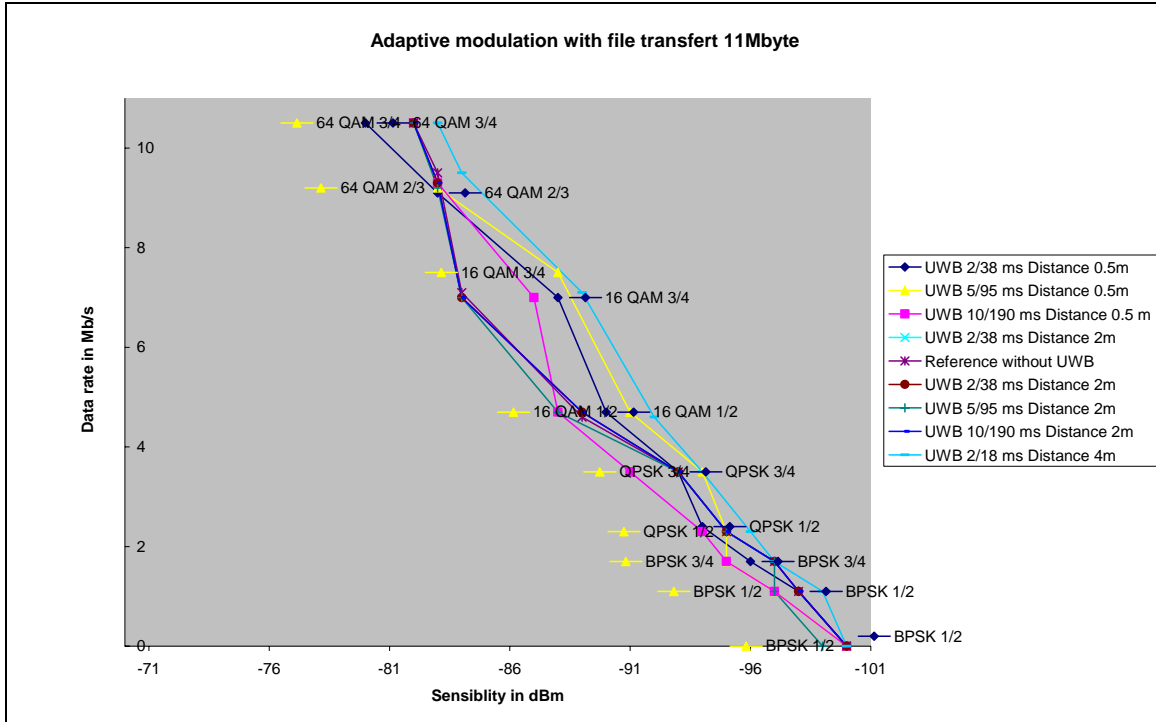

9.2 Impact on Throughput at cell edge

Throughput at the cell edge is measured with a Smartbit equipment that feeds the WiMax downlink with a 1 Mb/s data stream. WiMax link is configured at the lowest RSSI (-98 dBm). The impact created by UWB LDC is measured by increasing (if needed) the RSSI in order to obtain the reference throughput.

The figures presented in Annex 7 shows that the level of RSSI to obtain the reference throughput is almost unchanged.

This table shows evolution of the lowest needed RSSI to achieve a reliable 1 Mbit/s throughput with respect to UWB activity.

RSSI degradation to keep 1 Mb/s data rate (dB)		Distance (m)		
AF (Ton/Toff ms)		0.5	2	4
2%	0.75/38	0	0	N/A
	5/245	0	0	N/A
	10/490	1	1	N/A
	Aperiodic mode	0	N/A	N/A
5%	2/38	0	0	N/A
	5/95	0	0	N/A
	10/190	1	0	N/A
	Aperiodic mode	0	N/A	N/A
10%	2/18	1	0	N/A
	5/45	0	0	N/A
	10/90	1	0	N/A
	Aperiodic mode	0	N/A	N/A

9.3 WiMax turn-on synchronisation procedure

This test aimed to establish the impact of UWB interference when WiMax device is trying to establish connection with WiMax base station.

The test has been run in the following way :

- WiMax radio link established with lowest RSSI of -98dBm
- UWB LDC radio turned on with a given set of parameter
- WiMax SU (or AU) switched off
- WiMax SU (or AU) switched on
- WiMax reconnection checked

Activity Factor Ton / Toff in ms		RSSI at -99dBm Distance 0.5 m (SU Switch off)
5%	2/38	OK
	5/95	OK
	10/190	OK
	Aperiodic mode	OK
10%	2/18	OK
	Aperiodic mode	OK

SU device has always achieved the reconnection procedure in presence of UWB LDC without problem.

10 CONCLUSION ON MEASUREMENTS

In general, there is a slight impact on WiMax services but this is not significant. The degree of impact depends on the type of service used. For example, for video, users might experience some degradation over normal operating condition when they are at cell edge, in particular if they are located in close proximity to UWB LDC devices.

Furthermore, the impact reduction with respect to the distance between UWB transmitter and FWA receiver will likely prevent any aggregation effect. The activity factor of 0.5% per hour implies that UWB LDC will transmit not more than eighteen seconds per hour. Hence, the impact is limited in time and also on network structure of WiMax systems.

Owing to the lack of time, the aperiodic mode has been performed with one configuration of Ton/Toff for each activity factor. The results indicate an insignificant influence on WiMax services.

During these measurements, only the impact of the 5% per second limitation has been assessed, while the 0.5% per hour limitation is not covered (which would lead to lesser impact).

No WiMax system has lost its synchronisation during these measurements. As shown in these measurements, the choice of Ton and Toff for UWB LDC should be carefully assessed to reduce impact of WiMax systems.

Measurements on four potential WiMax user services; Video streaming, VoIP , data transfer and FTP, as well as WiMax operation (adaptive modulation, throughput and synchronisation) indicate that when the UWB activity factor is limited to 5%, the impact to WiMax system might be acceptable while measurement at 10% activity factor has shown some significant effect for some cases.

UWB implementing the proposed LDC limitation shown below can share frequency band with WiMax systems having a limited impact on services envisaged. The proximity of UWB LDC and WiMax systems is also an important element to take into account. All measurements are made with 0.5 meters, which will rarely occur, considering the target applications for UWB LDC, and when the distance increases, the situation is better.

It is assumed that WiMax system provided representative characteristics of FWA system in the 3.4 to 4.2GHz band.

Given the analysis above and the results presented in Annexes, it has been shown that coexistence between WiMax system and UWB implementing LDC for 1dB degradation at around 1m separation distance is possible. In most cases, separation distance of 0.5m does not result in significant degradation.

Hence, the following limitations are proposed.

<p>Ton max = 5 ms Toff mean \geq 38 ms (averaged over 1 sec) Σ Toff > 950 ms per second Σ Ton < 5% per second and 0.5% per hour PSD max -41.3 dBm/MHz</p>

11 FURTHER INVESTIGATION NEEDED

The studies/measurements should give confidence that LDC is capable to protect the FWA (and other possible) indoor usage in a technology neutral way.

For the time being, it could be assumed that Future Mobile Systems will be protected accordingly as for WiMAX systems.

When conditions of use of this frequency range by Future Mobile Systems are known, the efficiency of LDC mitigation technique should be reassessed. The regulatory parameters for LDC could then be revised within the frame of a review of the generic ECC Decision on UWB.

ANNEX 1: RANGING TECHNICAL REQUIREMENT

A typical technique used for performing ranging between 2 asynchronous devices is "Time Of Arrival with Two Way Ranging" (TOA-TWR), which is illustrated in the Figure below.

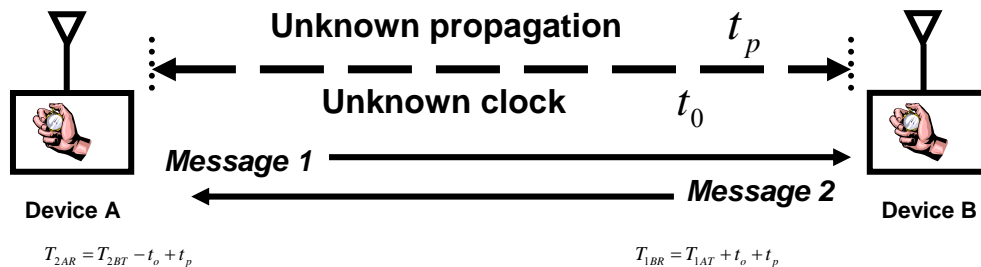

Two equations in two unknowns yield:

$$t_p = \frac{1}{2} [(T_{2AR} - T_{1AT}) - (T_{2BT} - T_{1BR})]$$

$$t_0 = \frac{1}{2} [(T_{2BT} + T_{1BR}) - (T_{2AR} + T_{1AT})]$$

Multiple measurements of t_p and t_0 yield finer precision & accuracy, and allow frequency offset correction.

* US Naval Observatory, *Telstar* Satellite, circa 1962
<http://www.boulder.nist.gov/timefreq/time/twoway.htm>
Unmatched detect-delays in the two devices may require one-time offset calibration.

Illustration of the TOA-TWR technique for ranging measurement

The elapsed time between the reception of the message by Device B and the emission of the ranging-ACK by this same device shall be as short as possible in order to minimize the impact of clock-drifting, which the accuracy of the measurement is highly dependent on. The minimal time for that is the turn-around time (for the receiving Device to become a transmitter) which is 250 μ s as derived from the 802.15.4 standard.

For a static network, we can take the following typical values for a ranging measurement between 2 devices :

- the emitted message from Device A, the draft 802.15.4a is describing some preamble-lengths for ranging at a 30 meters-range as long as a bit more than 4ms, followed by a 250 μ s-payload;
- Device B receives the message and uses 250 μ s-turnaround time;
- Device B transmits back the ranging-ACK message using a shorter preamble, around 1ms, followed by the 250 μ s-payload.

These considerations lead to the following technical requirements for UWB :

- T_{on} max should not be less than 6 ms;
- T_{off} min should not be more than 250 μ s.

combined with the low activity limitation to ensure no harmful interference towards existing services.

ANNEX 2: UWB LDC CAPTURED BY THE OSCILLOSCOPE (ILLUSTRATION OF TON/TOFF PARAMETERS)

Figure A2.1 and A2.2 show the UWB LDC signal captured by the oscilloscope for the periodic mode, for different parameters values.

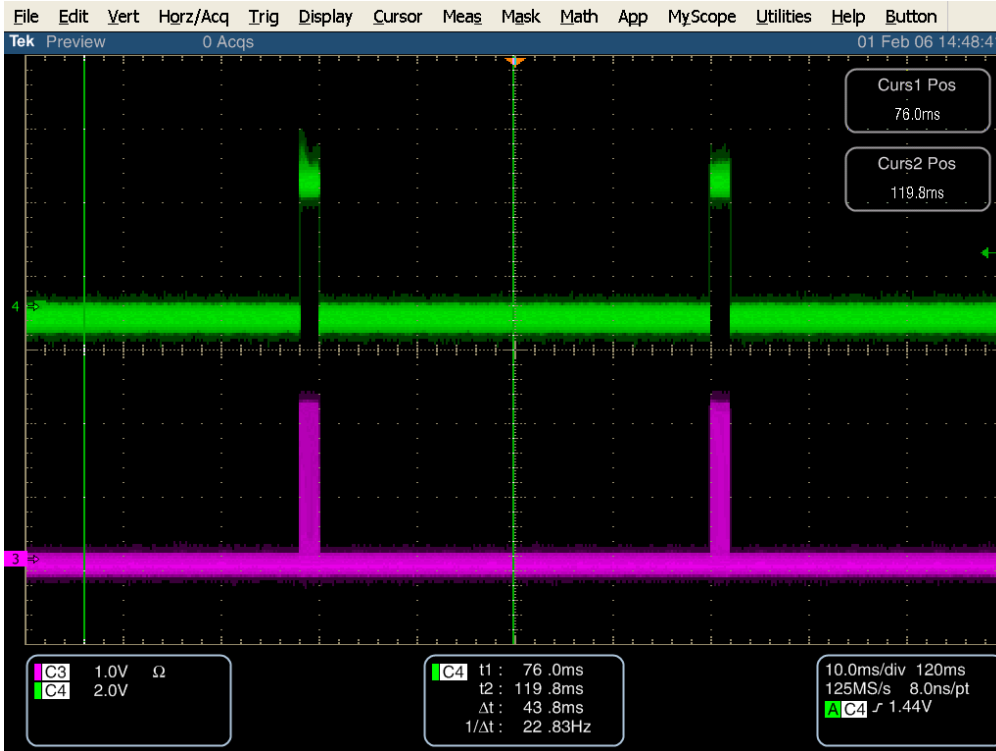

Fig A2.1 : Ton 2 ms and Toff 38 ms



Fig A2.2: Ton 5 ms and Toff 38 ms

Figures A2.3, A2.4, A2.5 represent the UWB LDC signal captured with the oscilloscope for the aperiodic mode, in which the UWB burst is located at the beginning of every second, whereas in the periodic mode, the UWB bursts are uniformly distributed over each second.

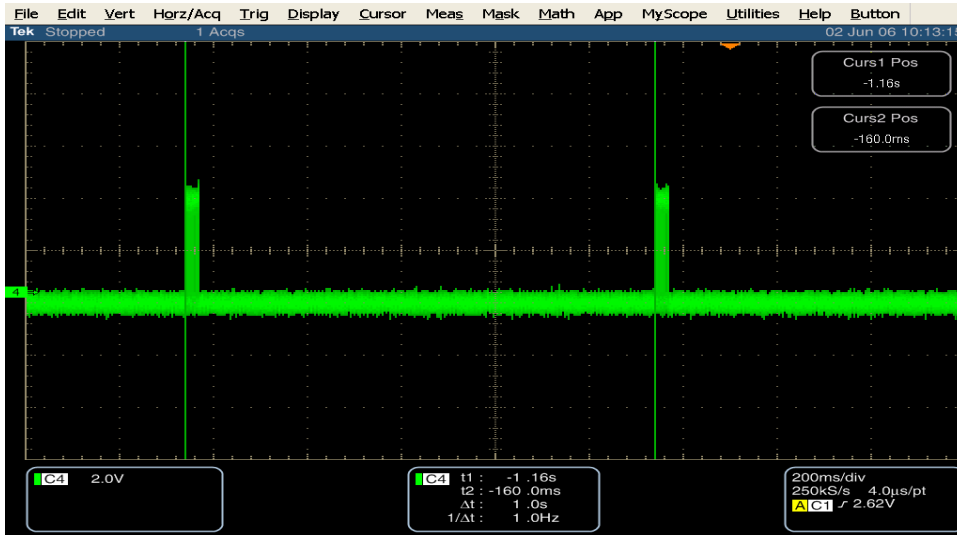

Figure A2.3 : Aperiodic mode, capture of 2 seconds

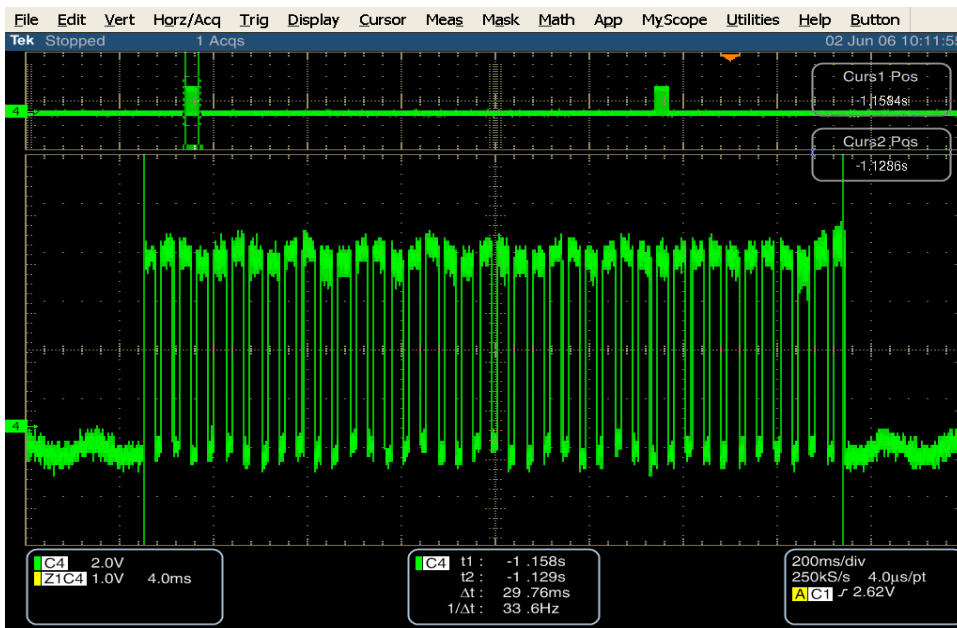

Figure A2.4 : Zoom of a A2.3 burst, composed of N times a Ton/Toff sequence (N depends on the AF°)



Figure A2.5 : Zoom of A2.corresponding to the 500 µs / 250 µs sequence

ANNEX 3: RADIO ENVIRONMENT CHARACTERIZATION

These measurement are obtained in "Max hold" mode.

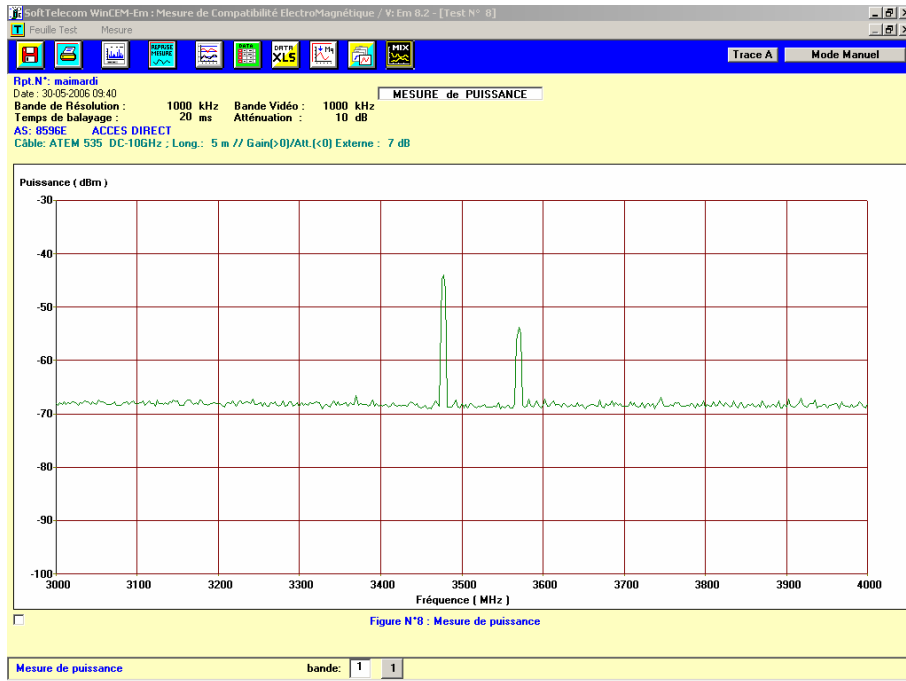

Figure A3.1: Measurement in band 3-4 GHz

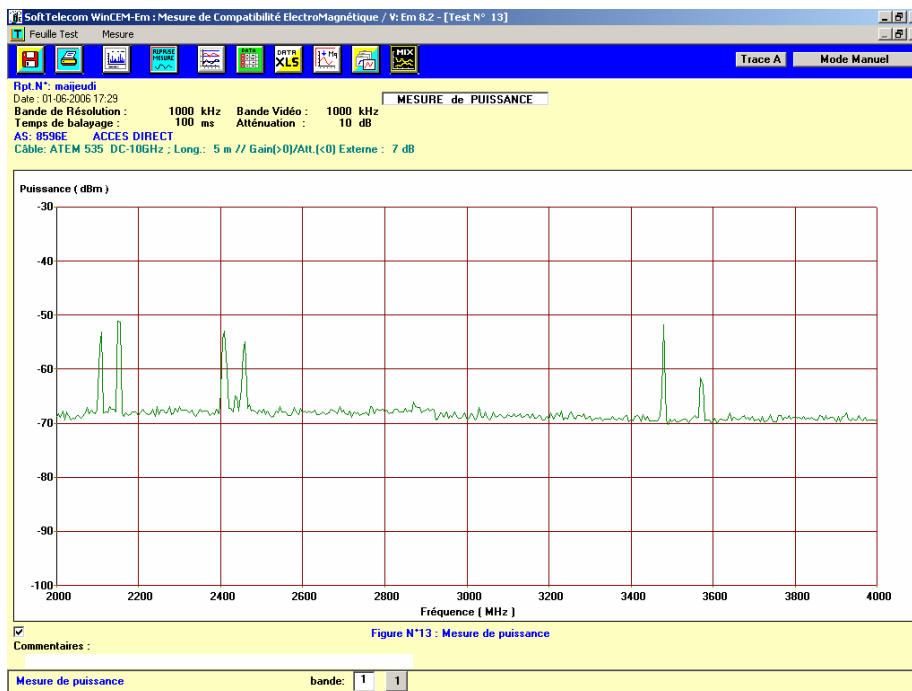

Figure A3.2: Measurement in conducted of UWB LDC



Figure A3.3: Measurement of Wimax Downlink

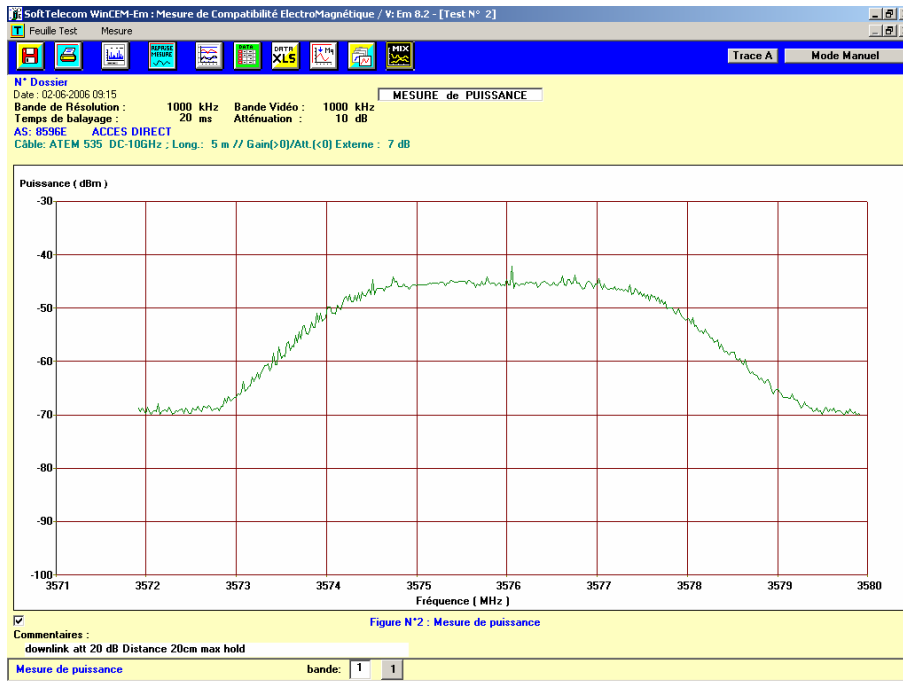
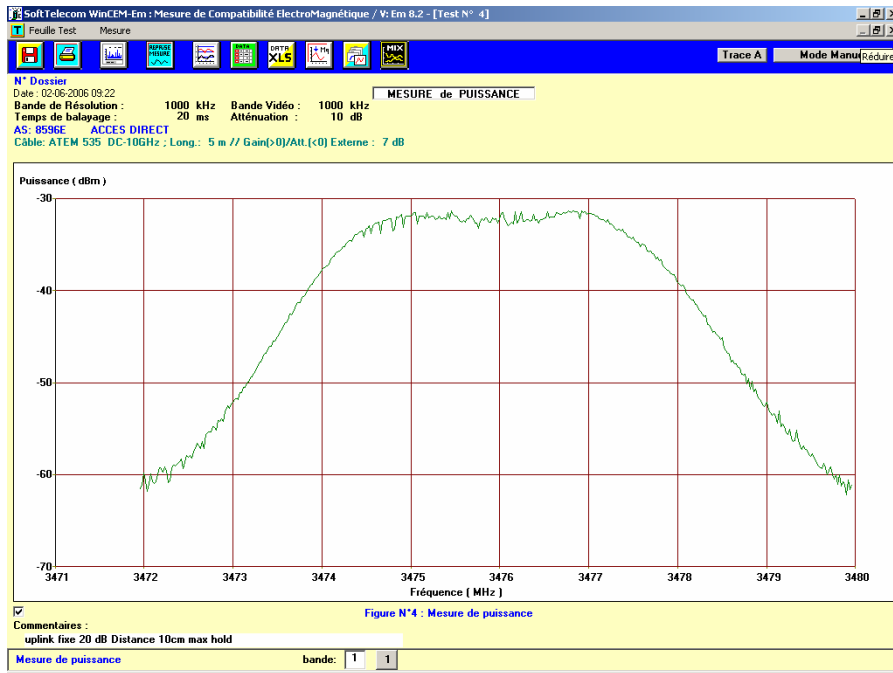

Figure A3.4: Measurement of Wimax Uplink



For other days, the environment was identical.

ANNEX 4: IMPACT ON VIDEO SERVICE

The following figure illustrates the impact of UWB LDC on Video services, noting that sensitivity level is obtained when frozen pictures occur.

A4.1 Preliminary test

Some preliminary test has been done with a set of parameters shown in the Figure below;

- Ton/Toff = 2/40 ms eqn to 5% AF
- Ton/Toff = 5/40 ms eqn to 12.5% AF
- Ton/Toff = 12/84 ms eqn to 14.3% AF
- Ton/Toff = 56/1340 ms eqn to 4.2% AF

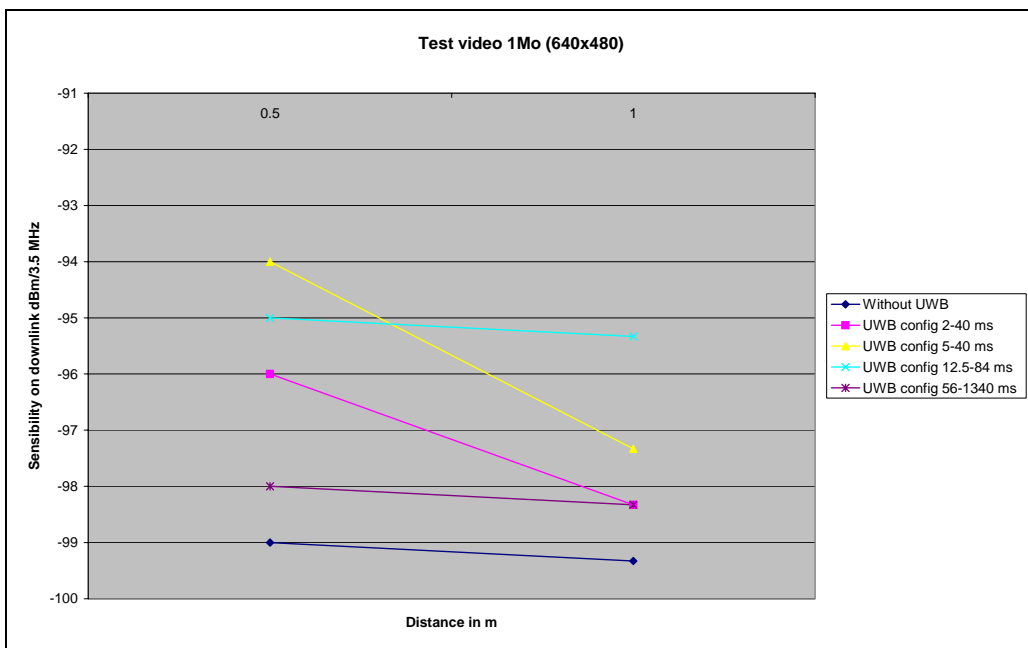

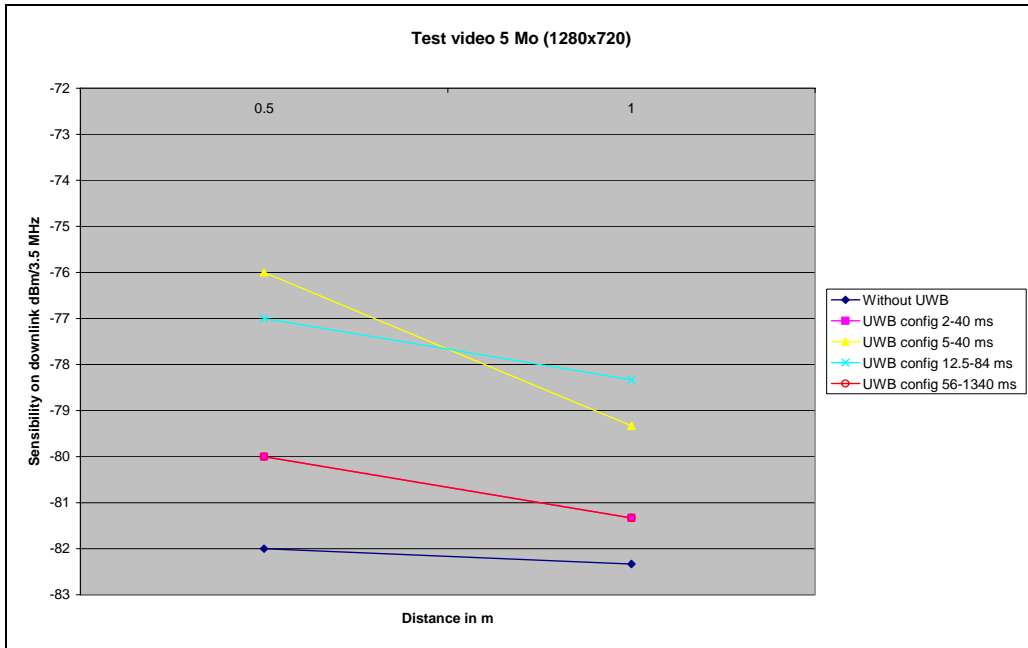

A4.2 Final Test Campaign

These Figures below illustrates the impact of LDC UWB emissions for the video service, given that the Wimax received signal strength (RSSI) might be increased to compensate the UWB interference.

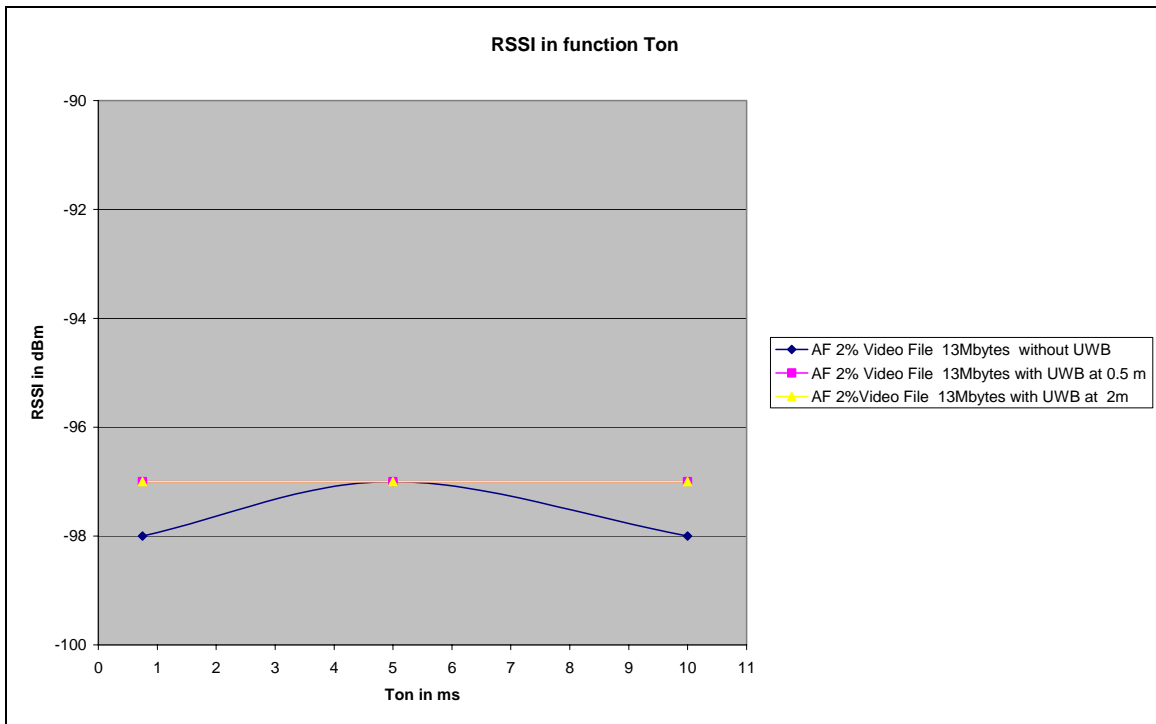

Figure A4.1: Activity Factor 2%

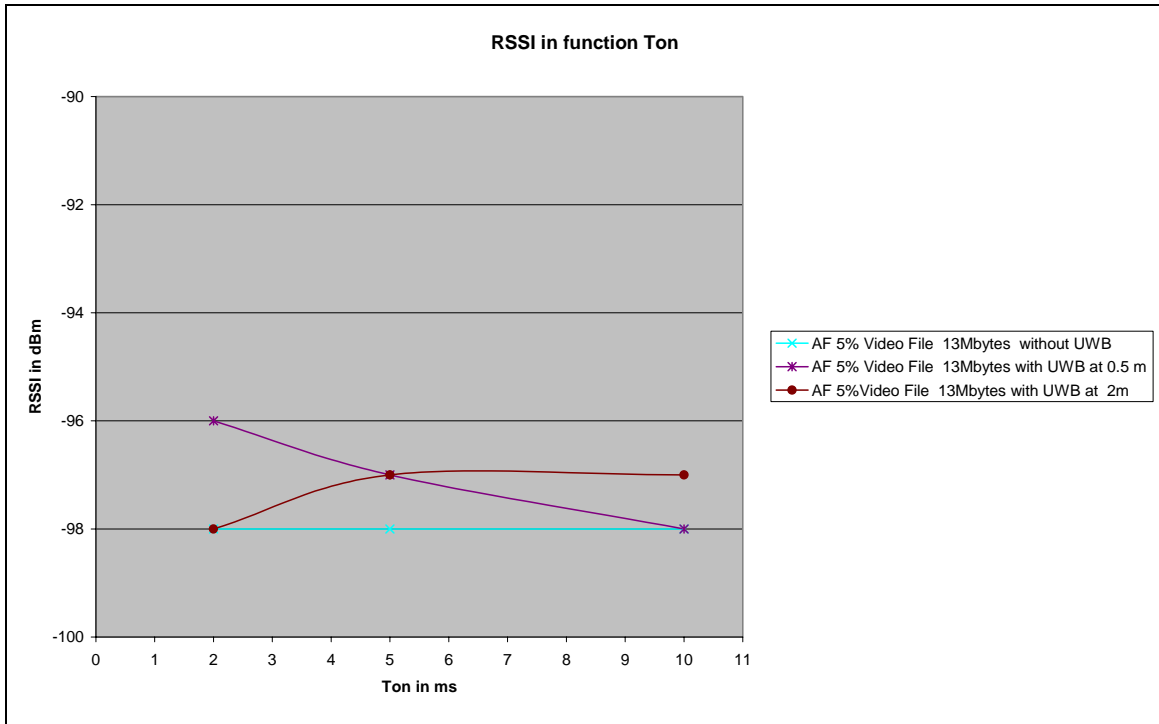

Figure A4.2: Activity Factor 5%

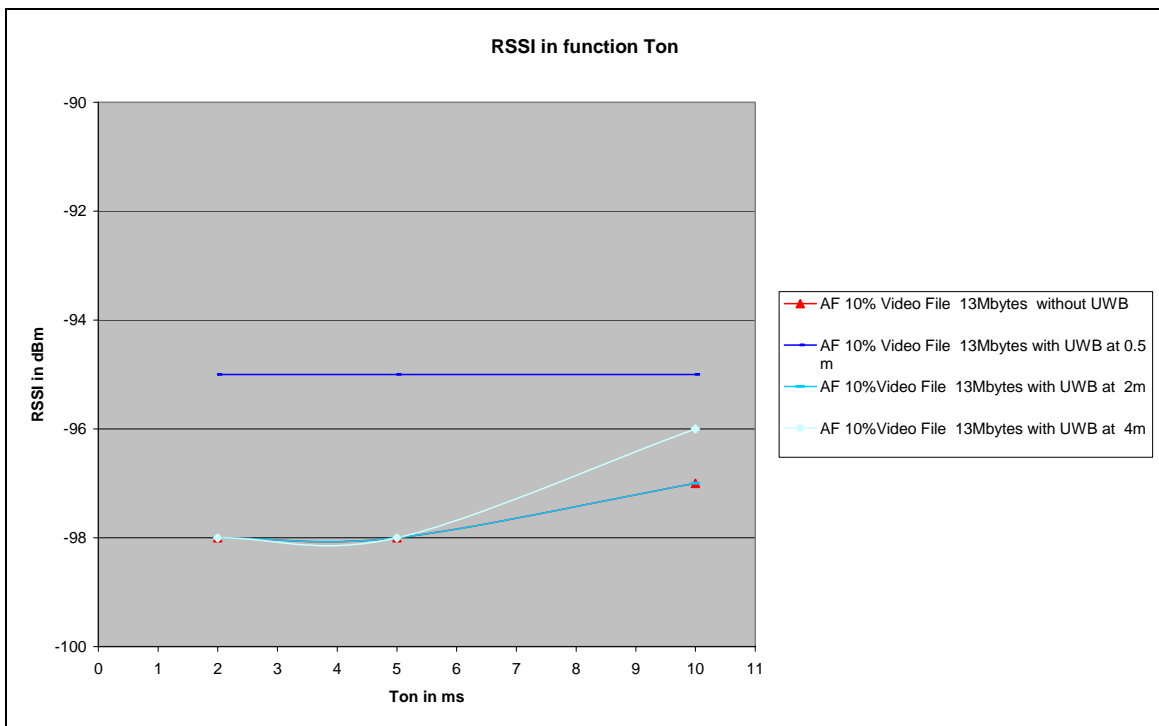

Figure A4.3: Activity Factor 10%

ANNEX 5: IMPACT ON VOIP

The following Table illustrates the observed impact of UWB LDC on VoIP services.

Scenario G711 (reference is note MOS without UWB LDC)

Activity Factor 2%	Note MOS Distance 0.5m/Reference	Note MOS Distance 2m/Reference
0.75/38	4.05/4.21	4.32/4.35
5/245	4.3/4.32	4.32/4.37
10/490	4.02/4.05	4.31/4.33

Scenario G729 (reference is note MOS without UWB LDC)

Activity Factor 2%	Note MOS Distance 0.5m/Reference	Note MOS Distance 2m/Reference
0.75/38	4.05/4.03	4.03/4.03
5/245	4.02/4.02	4.03/4.02
10/490	4.01/4.01	4.02/4.02

Scenario G711 (reference is note MOS without UWB LDC)

Activity Factor 5%	Note MOS Distance 0.5m/Reference	Note MOS Distance 2m/Reference
2/38	4.33/4.25	4.33/4.38
5/95	4.36/4.33	4.36/4.37
10/190	4.35/4.33	4.35/4.36

Scenario G729 (reference is note MOS without UWB LDC)

Activity Factor 5%	Note MOS Distance 0.5m/Reference	Note MOS Distance 2m/Reference
2/38	4.02/4.03	4.03/4.03
5/95	4.02/4.03	4.03/4.01
10/190	4.02/4.03	4.03/4.03

Scenario G711 (reference is note MOS without UWB LDC)

Activity Factor 10%	Note MOS Distance 0.5m/Reference	Note MOS Distance 2m/Reference
2/18	4.28/4.33	4.33/4.31
5/45	4.28/4.3	4.23/4.38
10/90	4.31/4.31	4.31/4.38

Scenario G729 (reference is note MOS without UWB LDC)

Activity Factor 10%	Note MOS Distance 0.5m/Reference	Note MOS Distance 2m/Reference
2/38	4.02/4.03	4.04/4.04
5/95	4/4.01	4.02/4.02
10/190	4.02/4.03	4.03/4.02

ANNEX 6: IMPACT ON FTP

The figure presented below shows that FTP services require approximately the same time to transfer data with and without UWB. In some cases, the performance with UWB devices seems to be better than without UWB devices. But for the different tests, the measurement conditions have changed slightly giving rise to small variations in measurement set up explaining the anomalies. Nevertheless, the differences are very small and the main conclusions remain.

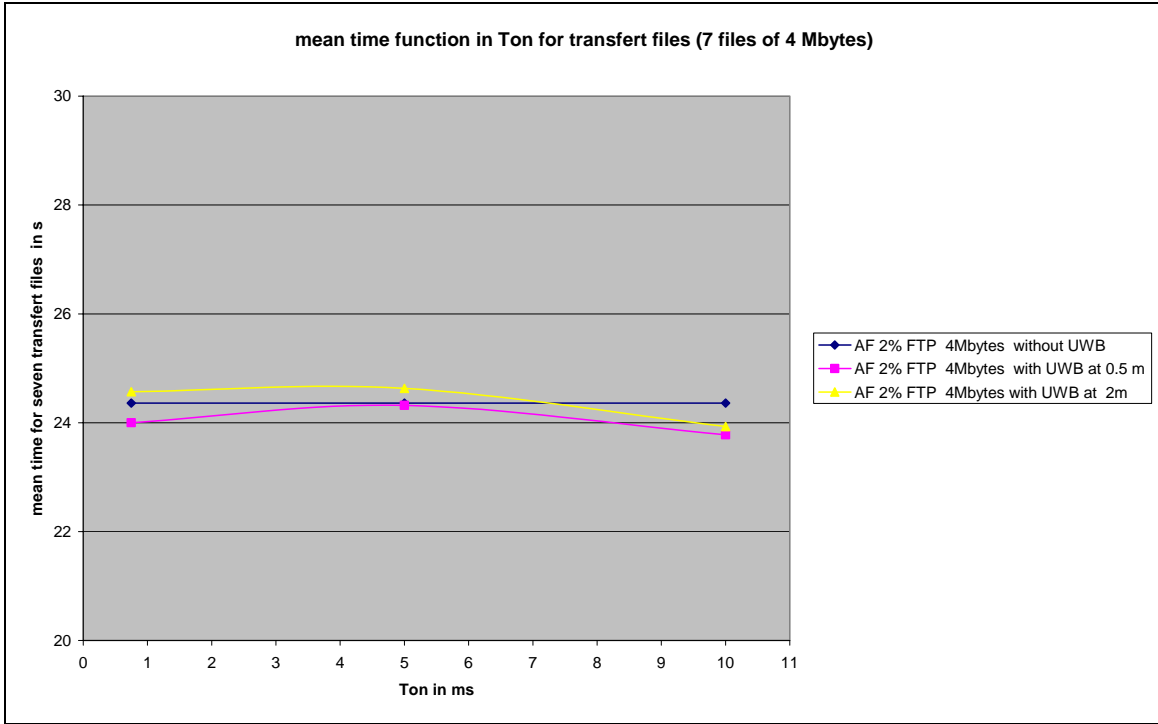

Figure A6.1: Activity factor 2%

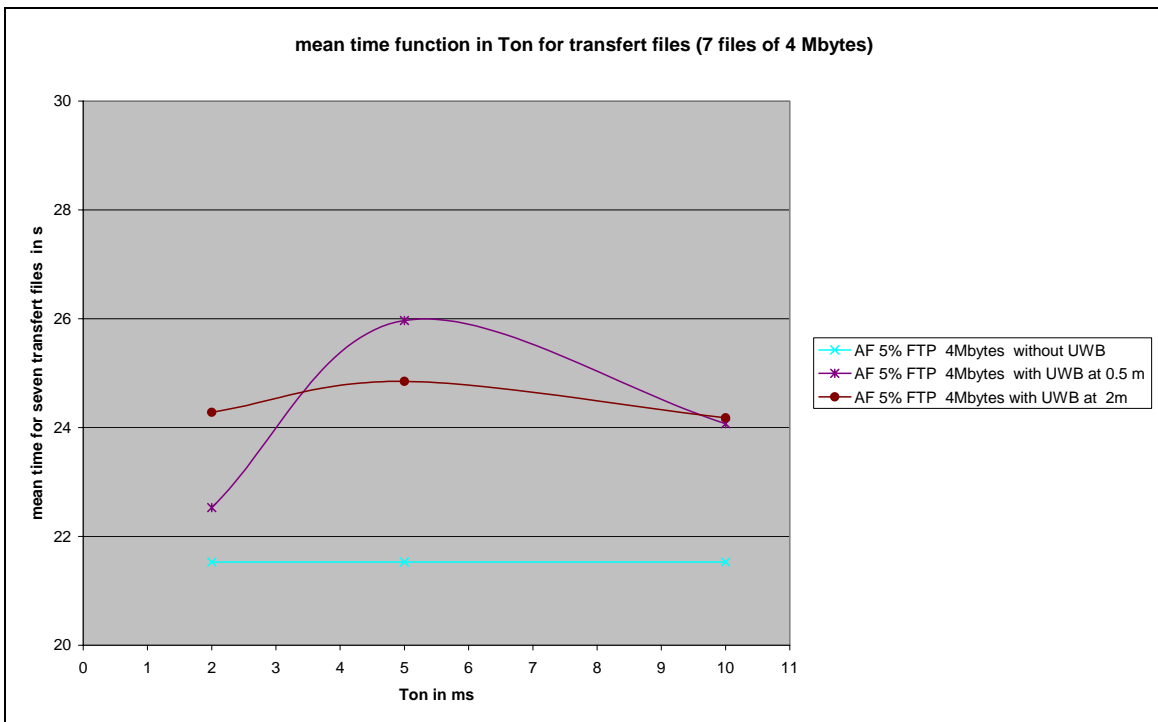

Figure A6.2: Activity factor 5%

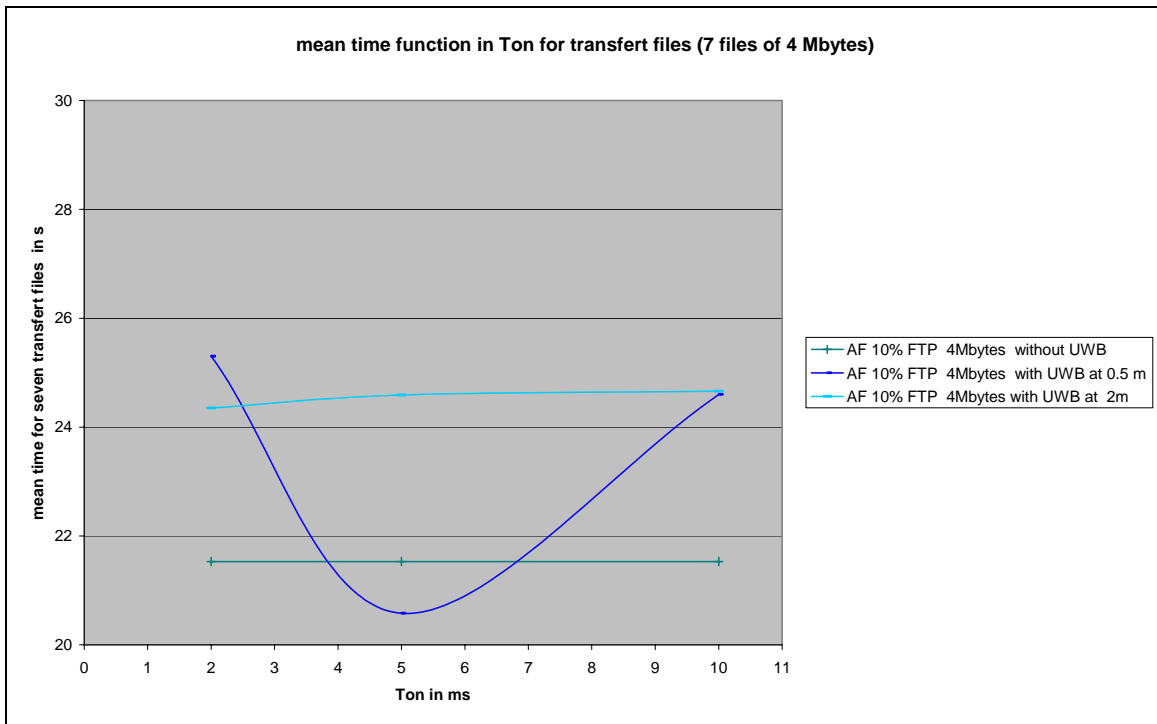

Figure A6.3: Activity factor 10%

Below is an example of the FTP files used to establish average on time duration.

Without UWB

```
C:\Documents and Settings\Ariane>ftp -s:fic -A 192.168.25.4
Connecté à 192.168.25.4.
220 R-W2KS-Belize Microsoft FTP Service (Version 5.0).
331 Anonymous access allowed, send identity (e-mail name) as password.
230 Anonymous user logged in.
Ouverture de session anonyme en tant que Ariane@OWA-Management
ftp> get log.bmp
200 PORT command successful.
150 Opening ASCII mode data connection for log.bmp(3932214 bytes).
226 Transfer complete.
ftp : 3932214 octets reçus en 25,97 secondes à 151,42 Ko/sec.
ftp> get log.bmp
200 PORT command successful.
150 Opening ASCII mode data connection for log.bmp(3932214 bytes).
226 Transfer complete.
ftp : 3932214 octets reçus en 24,77 secondes à 158,78 Ko/sec.
ftp> get log.bmp
200 PORT command successful.
150 Opening ASCII mode data connection for log.bmp(3932214 bytes).
226 Transfer complete.
ftp : 3932214 octets reçus en 24,47 secondes à 160,70 Ko/sec.
ftp> get log.bmp
200 PORT command successful.
150 Opening ASCII mode data connection for log.bmp(3932214 bytes).
226 Transfer complete.
ftp : 3932214 octets reçus en 24,53 secondes à 160,30 Ko/sec.
ftp> get log.bmp
200 PORT command successful.
```

150 Opening ASCII mode data connection for log.bmp(3932214 bytes).
226 Transfer complete.
ftp : 3932214 octets reçus en 24,64 secondes à 159,58 Ko/sec.
ftp> get log.bmp
200 PORT command successful.
150 Opening ASCII mode data connection for log.bmp(3932214 bytes).
226 Transfer complete.
ftp : 3932214 octets reçus en 25,34 secondes à 155,15 Ko/sec.
ftp> get log.bmp
200 PORT command successful.
150 Opening ASCII mode data connection for log.bmp(3932214 bytes).
226 Transfer complete.
ftp : 3932214 octets reçus en 24,31 secondes à 161,74 Ko/sec.
ftp> quit
Average time : 24,86 s Average data rate : 158 ko/s

UWB 10 90

C:\Documents and Settings\Ariane>ftp -s:fic -A 192.168.25.4
Connecté à 192.168.25.4.
220 R-W2KS-Belize Microsoft FTP Service (Version 5.0).
331 Anonymous access allowed, send identity (e-mail name) as password.
230 Anonymous user logged in.
Ouverture de session anonyme en tant que Ariane@OWA-Management
ftp> get log.bmp
200 PORT command successful.
150 Opening ASCII mode data connection for log.bmp(3932214 bytes).
226 Transfer complete.
ftp : 3932214 octets reçus en 24,80 secondes à 158,58 Ko/sec.
ftp> get log.bmp
200 PORT command successful.
150 Opening ASCII mode data connection for log.bmp(3932214 bytes).
226 Transfer complete.
ftp : 3932214 octets reçus en 24,86 secondes à 158,18 Ko/sec.
ftp> get log.bmp
200 PORT command successful.
150 Opening ASCII mode data connection for log.bmp(3932214 bytes).
226 Transfer complete.
ftp : 3932214 octets reçus en 25,19 secondes à 156,11 Ko/sec.
ftp> get log.bmp
200 PORT command successful.
150 Opening ASCII mode data connection for log.bmp(3932214 bytes).
226 Transfer complete.
ftp : 3932214 octets reçus en 23,86 secondes à 164,80 Ko/sec.
ftp> get log.bmp
200 PORT command successful.
150 Opening ASCII mode data connection for log.bmp(3932214 bytes).
226 Transfer complete.
ftp : 3932214 octets reçus en 25,63 secondes à 153,45 Ko/sec.
ftp> get log.bmp
200 PORT command successful.
150 Opening ASCII mode data connection for log.bmp(3932214 bytes).
226 Transfer complete.
ftp : 3932214 octets reçus en 24,25 secondes à 162,15 Ko/sec.
ftp> get log.bmp
200 PORT command successful.
150 Opening ASCII mode data connection for log.bmp(3932214 bytes).
226 Transfer complete.
ftp : 3932214 octets reçus en 24,06 secondes à 163,41 Ko/sec.
ftp> quit
Average time: 24,66 s Average data rate : 159,4 ko/s

ANNEX 7: THROUGHPUT AND ADAPTIVE MODULATION

A7.1 Throughput

The figures presented below shows that the level of RSSI to obtain the reference throughput is almost unchanged.

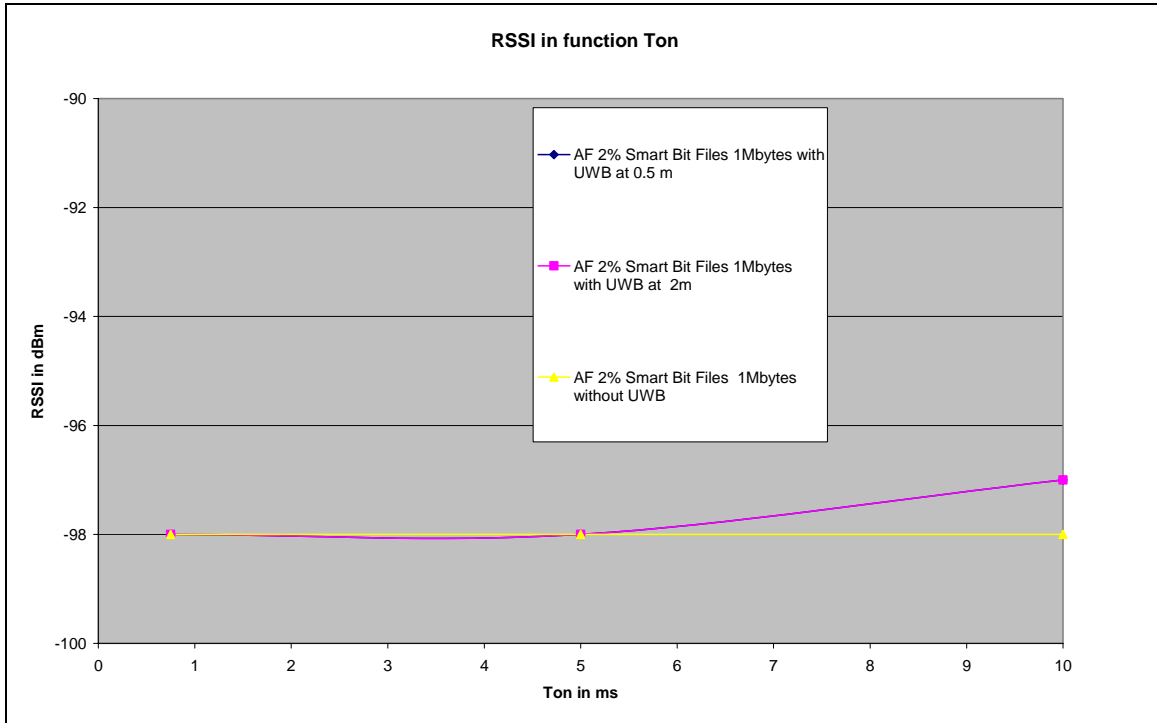

Figure A7.1: Activity factor 2%

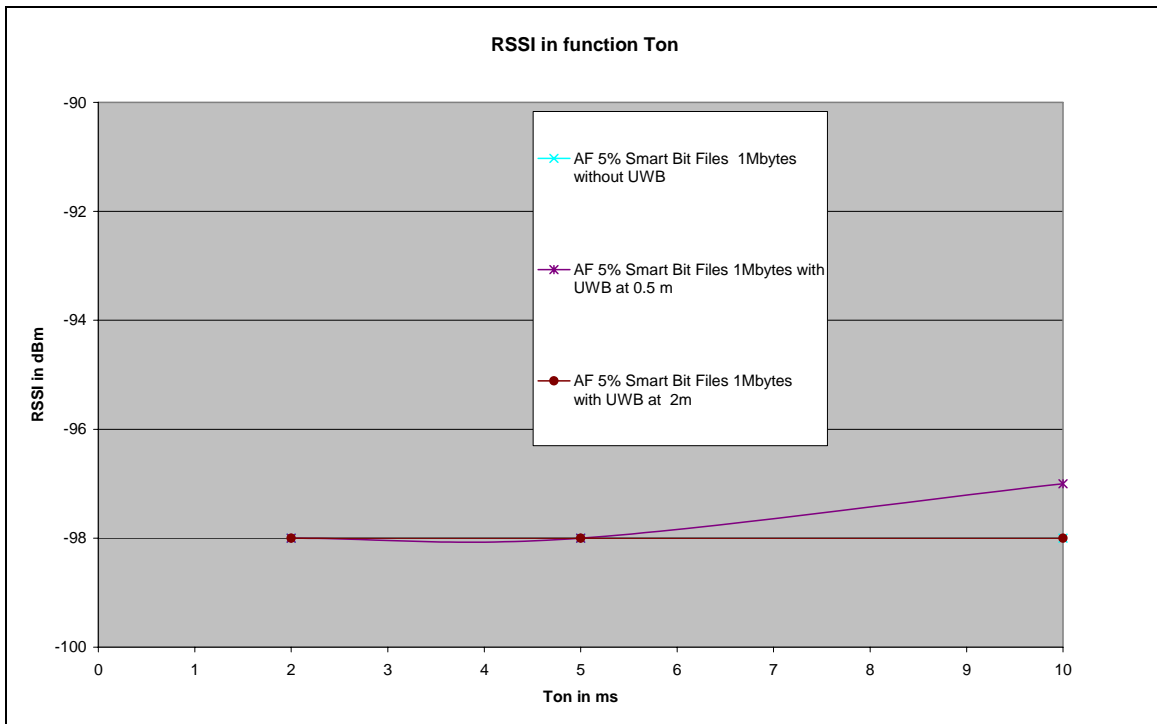

Figure A7.2: Activity factor 5%

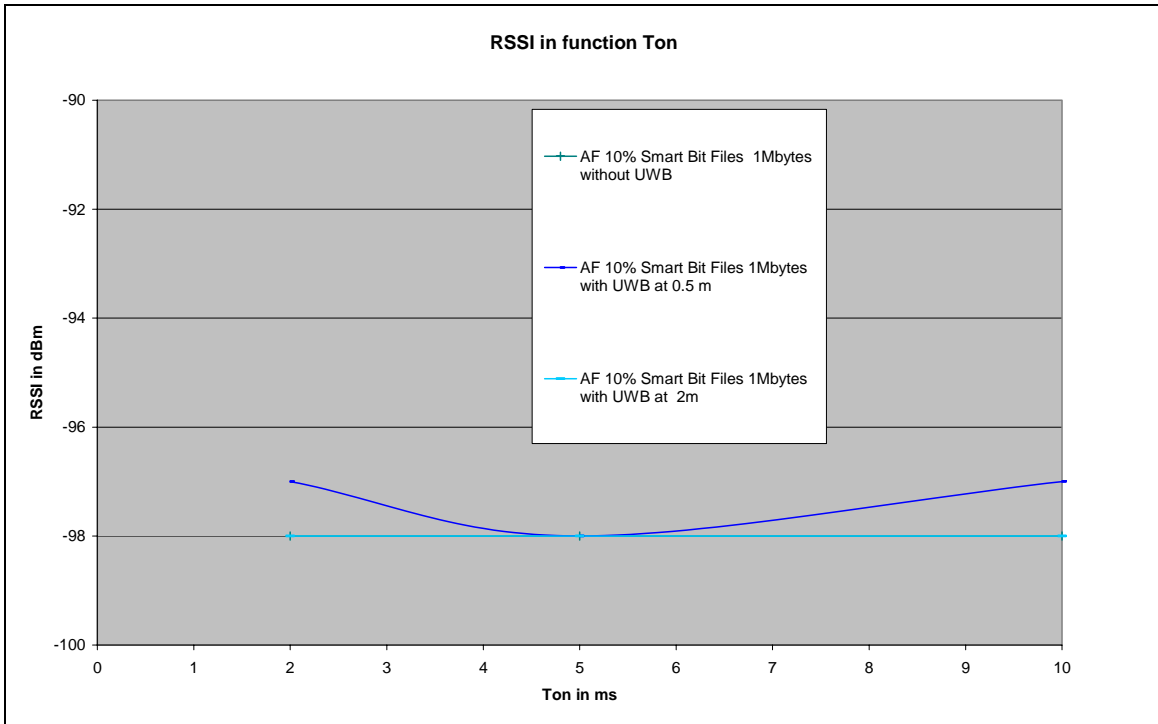

Figure A7.3: Activity factor 10%

Preliminary Test

Adaptive modulation

This measurement presents how adaptive modulation reacts when transmitting 11 Mbit file. The attenuator is decrease step by step per 5dB. This measurement is done by comparing with UWB transmitting 100% activity factor.

