



Electronic Communications Committee (ECC)
within the European Conference of Postal and Telecommunications Administrations (CEPT)

**MEASUREMENTS ON THE PERFORMANCE OF DVB-T RECEIVERS IN THE
PRESENCE OF INTERFERENCE FROM THE MOBILE SERVICE
(ESPECIALLY FROM LTE)**

Marseille, June 2010

0 EXECUTIVE SUMMARY

This Report summarises the CEPT activity relating to measurements on the performance of DVB-T receivers¹ in terms of measured carrier-to-interference protection ratios and overloading thresholds in the presence of interference from the mobile service, especially that from LTE. It is aimed to assist administrations seeking to protect their broadcasting services in the band 470-790 MHz from interference generated by LTE in the band 790-862 MHz.

The Report is complementary to ECC Report 138, which addresses the performance of DVB-T receivers in the presence of interference from UMTS.

¹ This Report does not cover active antennas nor antenna amplifiers that may be installed in the receiver chain.

Table of contents

0	EXECUTIVE SUMMARY	2
	LIST OF ABBREVIATIONS.....	4
1	INTRODUCTION	5
2	USEFUL DEFINITIONS.....	5
2.1	RADIO FREQUENCY SIGNAL-TO-INTERFERENCE RATIO (C/I)	5
2.2	RADIO FREQUENCY PROTECTION RATIO (PR).....	5
2.3	RECEIVER BLOCKING.....	6
2.4	RECEIVER (FRONT-END) OVERLOADING THRESHOLD	6
2.5	“CAN” TUNERS	6
2.6	“SILICON” TUNERS.....	6
3	CRITERIA TO BE USED WHEN ASSESSING INTERFERENCE.....	6
4	MEASUREMENTS.....	7
4.1	BROADCASTING SERVICE PARAMETERS	7
4.2	MOBILE SERVICE PARAMETERS.....	7
4.3	TEST PROCEDURE.....	9
4.3.1	<i>Measurements under static conditions.....</i>	<i>10</i>
4.3.2	<i>Time varying interference source signals.....</i>	<i>10</i>
4.3.3	<i>Measurements in a time variant Rayleigh transmission channel for the wanted DVB-T signal</i>	<i>10</i>
4.4	RECEIVER TYPES	11
5	PROTECTION RATIOS	12
5.1	LTE BASE STATION INTERFERING SIGNAL.....	14
5.2	LTE USER EQUIPMENT INTERFERING SIGNAL	15
6	CONCLUSION	16
	ANNEX A: METHOD TO DERIVE THE RECEIVER OVERLOADING THRESHOLD	18
	ANNEX B: SEQUENCES USED FOR MEASUREMENTS ON LTE USER EQUIPMENT SIGNALS	23
	ANNEX C: MEASUREMENT SET-UP	26
	ANNEX D: STATISTICS ON RECEIVERS.....	27
	ANNEX E: STUDIES ON POSSIBLE TECHNIQUES TO MITIGATE INTERFERENCE FROM LTE IN THE DOMESTIC ENVIRONMENT.....	28
	ANNEX F: INFLUENCE OF THE LTE SIGNAL BANDWIDTH ON THE PROTECTION RATIO	29
	ANNEX G: SOURCE DOCUMENTS OF PROTECTION RATIO MEASUREMENTS	31
	ANNEX H: LIST OF REFERENCES.....	32

LIST OF ABBREVIATIONS

ACLR	Adjacent Channel Leakage Ratio
AF	Audio Failure
AWGN	Additive White Gaussian Noise
BS	Base station
BEM	Block Edge Mask
BER	Bit error ratio
CEPT	European Conference of Postal and Telecommunications Administrations
C/I	Signal-to-interference ratio
COFDM	Coded Orthogonal Frequency Division Multiplexing
DVB-T	Digital Video Broadcasting – Terrestrial
ECC	Electronic Communications Committee
ESR	Error Second Ratio
FDD	Frequency Division Duplex
GE06	The Geneva 2006 Agreement
GSM	Global System for Mobile communications
iDTV	integrated digital TV receiver
IMT	International Mobile Telecommunications
ITU-R	International Telecommunication Union - Radiocommunication Sector
LTE	Long Term Evolution
PF	Picture failure
PR	Protection ratio
PVR	Personal Video Recorder
QEF	Quasi Error Free
RRC-06	Regional Radiocommunication Conference, Geneva 2006
O_{th}	Overloading threshold
SC-FDMA	Single Carrier Frequency Division Multiple Access
TPC	Transmit Power Control
UE	User equipment
UMTS	Universal Mobile Telecommunications System
WCDMA	Wideband Code Division Multiple Access
WRC-07	World Radiocommunication Conference 2007

Measurements on the performance of DVB-T receivers in the presence of interference from the mobile service (especially from LTE)

1 INTRODUCTION

WRC-07 co-allocated the band 790-862 MHz (channels 61-69) to the mobile service (except aeronautical mobile) on a primary basis from 17 June 2015 in Region 1 with an identification of the band for IMT. In some European countries this allocation is valid before 2015 subject to technical coordination with other countries contracting to the GE06 Agreement.

ECC Report 138 [1] summarised the CEPT activity relating to measurements on the performance of DVB-T receivers in the presence of interference from the WCDMA mobile service (UMTS) in the band 790-862 MHz. It was also noted that LTE was expected to be more widely deployed than UMTS in this band. Therefore, measurements on LTE interference into DVB-T reception have been carried out in order to assess the impact of this on the broadcasting service.

This Report summarises the CEPT activity relating to measurements on the performance of DVB-T receivers² in terms of measured carrier-to-interference protection ratios and overloading thresholds in the presence of interference from LTE. It is aimed to assist administrations seeking to protect their broadcasting services in the band 470-790 MHz from interference generated by LTE in the band 790-862 MHz.

It has to be noted that the Report is based on the information available at the time it was developed. A further set of measurements should be done when the LTE equipment for the band 800 MHz is commercially available.

2 USEFUL DEFINITIONS

2.1 Radio frequency signal-to-interference ratio (C/I)

It is the ratio, generally expressed in dB, of the power of the wanted signal to the total power of interfering signals and noise, evaluated at the receiver input (see Rec. ITU-R V.573-5 [2]).

Usually, C/I is expressed as a function of the frequency offset between the wanted and interfering signals over a wide frequency range. In this document, C/I expressed in this way is referred to as “C/I curve”. C/I curves show the ability of a receiver to discriminate against interfering signals on frequencies differing from that of the wanted signal.

2.2 Radio frequency protection ratio (PR)

It is the minimum value of the signal-to-interference ratio required to obtain a specified reception quality under specified conditions at the receiver input (note that this differs from the definition in Rec. ITU-R V.573-5 [2]). In this report, the “specified reception quality” and the “specified conditions” have been defined separately by each entity that has undertaken measurements.

Usually, PR is specified as a function of the frequency offset between the wanted and interfering signals over a wide frequency range. In this document, PR specified in this way is referred to as “PR curve”. PR curves show the ability of a receiver to discriminate against interfering signals on frequencies differing from that of the wanted signal.

It should be stressed that the protection ratios are generally considered and used as independent of the wanted signal level. That is C(I) is supposed to be a linear function with unity slope (a straight line with unity slope). The protection ratio of the receiver is obtained by subtracting I from C(I) at any points on this line and can be used for all wanted signal levels. However, the measurement results show that in most cases the protection ratios of wideband TV receivers vary as a function of the wanted signal level. Consequently, C(I) is not a straight line with unity slope with some variation with the wanted signal strength. Nevertheless, for interfering signals below the overloading threshold such C(I) curves can always be approximated by a straight line with unity slope with an acceptable error. This method has been used in this report for determining the PR of DVB-T receivers (see **Annex A**).

² This Report does not cover active antennas nor antenna amplifiers that may be installed in the receiver chain.

2.3 Receiver Blocking

Receiver blocking is the effect of a strong out-of-band interfering signal on the receiver's ability to detect a low-level wanted signal. Receiver blocking response (or performance level) is defined as the maximum interfering signal level expressed in dBm reducing the specified receiver sensitivity by a certain number of dB's (usually 3 dB). Consequently, the receiver blocking response is normally evaluated at a wanted signal level which is 3 dB above the receiver sensitivity and at frequencies differing from that of the wanted signal.

2.4 Receiver (front-end) overloading threshold

Overloading threshold (Oth) is the interfering signal level expressed in dBm, above which the receiver begins to lose its ability to discriminate against interfering signals at frequencies differing from that of the wanted signal (i.e., the onset of strong non-linear behaviour). Therefore, above the overloading threshold the receiver will behave in a non-linear way, but does not necessarily fail immediately depending on the receiver characteristics and interference characteristics.

2.5 "Can" tuners

"Can" tuners are classical super heterodyne tuners housed in a metal enclosure containing discrete components. Classically, there are fixed and tunable circuits made up from discrete inductors and transistors usually with varactor diode frequency control. The metal enclosure should minimize RF interference and eliminate crosstalk and stray radiation. (See Section 4.4 for more details on receiver architecture.)

2.6 "Silicon" tuners

"Silicon" tuners are IC-based tuners integrating all tuner circuitry into a small package directly to be fitted onto main boards. The tuned circuits may be completely absent or can be integrated onto the silicon. The silicon chip may be protected from external electromagnetic interference by a metallic cover. When integrated onto the silicon there is a compromise in performance when compared with discrete classical layouts. The units measured represent an early generation on the market. This technology is still developing. (See Section 4.4 for more details on receiver architecture.)

3 CRITERIA TO BE USED WHEN ASSESSING INTERFERENCE

DVB-T systems use coded orthogonal frequency division multiplexing (COFDM) which spreads the information over a large number of orthogonal carriers. Forward error correction is then applied to improve the bit error ratio (BER). In many digital systems the data to be transmitted undergoes two types of FEC coding; Reed Solomon and convolutional coding (Viterbi). At the receiver end, the pseudo-random sequence added at the transmitter by the convolutional encoder is decoded by the Viterbi decoder, followed by Reed Solomon decoding for parity checking.

The error protection employed by such digital systems usually results in an abrupt "cliffedge" effect in the presence of interference when compared to analogue systems. There are several criteria which can be used when assessing interference to digital systems, including:

- Post Viterbi Bit Error Rate (BER) of 2×10^{-4}
- A measure of the number of un-correctable Transport Stream errors in a defined period (sometimes also normalized to 'Error Seconds' or provided as "Error Second Ratio", ESR).
- "Picture Failure". Number of observed (or detected) picture artefacts in a defined period.
- "Subjective failure point"
- "Audio Failure". Number of detected audio errors in a defined period.

The reference BER, defined as $BER = 2 \times 10^{-4}$ after Viterbi decoding, corresponds to the quasi error free (QEF) criterion in the DVB-T standard, which states "less than one uncorrelated error event per hour". However, there is often no direct way of identifying BER or transport stream errors for commercial receivers. In this case picture failure (PF) and audio failure (AF) are the only means of assessing the interference effects.

In all measurements reported here, receiver sensitivity, protection ratios as well as overloading thresholds were determined by ensuring the absence of a picture failure during a minimum observation time of 30 seconds.

4 MEASUREMENTS

The measurements presented in this report were conducted in France, Germany (two measurements campaigns from IRT and Media Broadcast), the United Kingdom, and by some receiver manufacturers (Sony, Philips, Panasonic, NXP and LG). Because of the different targeted broadcasting modulation schemes and reception conditions, various broadcasting service parameters were used. Moreover, different measurement setups with diverse approaches to generate the LTE interfering signal were used in different laboratories. However, the results on measured carrier-to-interference protection ratios and overloading thresholds in the presence of interference from LTE are harmonised to the extent possible to the format/presentation suitable for the application by administrations.

In all measurement campaigns, only a single wanted signal and a single interfering signal was considered. Furthermore, it is noted that LTE networks are not yet operational in the 800 MHz band and, therefore, these measurements were carried out under certain assumptions. This refers, in particular, to the variation of the LTE UE signal in the time and frequency domain.

4.1 Broadcasting service parameters

The DVB-T parameters used as the wanted signal source in different measurements are shown in Table 1.

Parameter	Value
Multiple access	COFDM
Modulation	64-QAM (F, UK, Manufacturers) 16-QAM (D)
Forward error correction	2/3 (D, UK, Manufacturers) 3/4 (F)
FFT points	8 k
Channel bandwidth	8 MHz
Wanted signal level used (dBm)	-80... -75dBm, in steps of 10dB up to -30dBm

Table 1: DVB-T parameters used in measurements

4.2 Mobile service parameters

The LTE BS interfering signal parameters used in different measurements are given in Table 2.

Parameter	Value
Multiple access method	OFDMA
Duplex	FDD
Channel bandwidth	5 MHz (D, Manufacturers) 10 MHz (F, UK)
Sub-frame length	1 ms
Allocated resource block	50
Number of OFDM sub-carriers	12
Sub-carrier bandwidth	15 kHz
Channel modulation	QPSK
Code rate	1/3
Number of users	1
Data pattern	9 PBRS

Table 2: LTE Base Station signal parameters used in measurements

The conformity of the unwanted emissions of the LTE BS signal with the Block Edge Mask (BEM) defined in CEPT Report 30 [4] has been ensured. Figure 1 shows an example of LTE BS interference signal at maximum power after amplification and band pass filtering alongside the CEPT BEM.

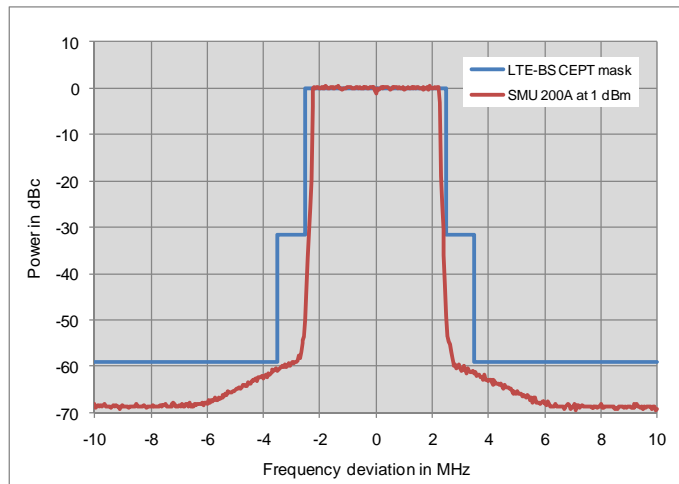

Figure 1: LTE BS Spectrum after amplification and filtering compared with CEPT BEM

It should be noted that, in practice, the 3GPP LTE spectrum emission mask (SEM) is already achieved through the BS drive circuits & power amplification. However, additional band pass RF filtering with sufficient attenuation is required to reduce the emissions from the levels set by the 3GPP LTE SEM down to the appropriate regulatory BEM baseline limit developed by the CEPT [4]. The band pass filter reduces the out of band power beyond a certain frequency offset (usually starting from the 4th adjacent channel). To be close to the real world situation most of the measurements provided in this report were set up with the band pass filter. However, in one measurement campaign conducted in Germany the band pass filter was not used, though the spectrum emission mask of the output signal was still confined within the “regulatory” mask defined by the CEPT. The results obtained within this measurement campaign have been normalised to the case of the band pass filter on the basis of the comparison made between the data for wide band and band pass filtered measurements.

The LTE UE interfering signal parameters used in different measurements are given in Table 3.

Parameter	Value
Multiple access method	SC-FDMA
Duplex	FDD
Channel bandwidth	5 MHz
Sub-frame length	1 ms
Allocated resource block	25
Sub-carrier bandwidth	15 kHz
Number of users (active devices)	1

Table 3: LTE User Equipment signal parameters used in measurements

The LTE UE interfering signal used in the measurements had 5 MHz bandwidth and was in conformity with the required spectrum mask for LTE UE as defined in the 3GPP standard [3]. Figure 2 shows the interference LTE UE signal after amplification and band pass filtering alongside the mask from 3GPP.

It is expected that LTE UE will have to be compliant with the BEM of -65 dBm in 8 MHz for all TV channels below 790 MHz. This BEM is more than 40 dB more constraining than the LTE UE spectrum mask of the 3GPP. For FDD terminals the duplexer will naturally provide this extra-filtering. It means that for an assumed maximum power of 23 dBm, the required Adjacent Channel Leakage Ratio should be at least 88 dB below 790 MHz.

In one measurement campaign in Germany, the ACLR of the interference signal was 70 dB, corresponding to a protection ratio of roughly -60 dB. Therefore, the actual protection ratio may be better than measured where the protection ratio is approaching this value. In the other measurement campaign in Germany, measurements have been made with a suppression of more than 80 dB of out-of-band emissions within the frequency range of wanted DVB-T signals.

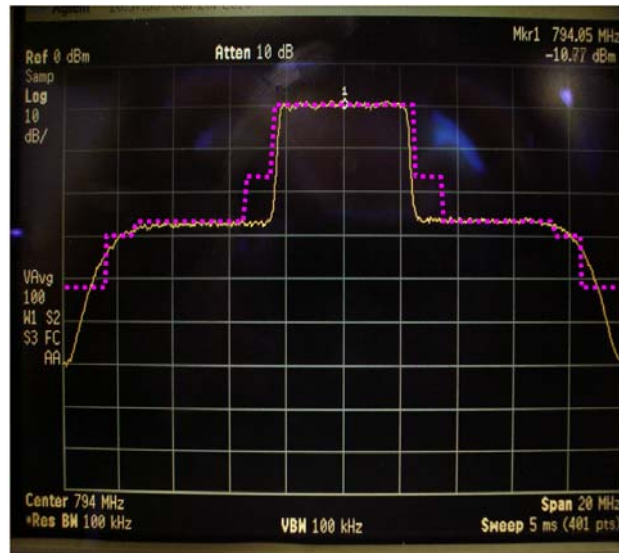

Figure 2: LTE UE signal after amplification and filtering compared with 3GPP mask (for 5 MHz bandwidth) as used in the measurements by receiver manufacturers

Furthermore, different LTE signal structures (time sequences and variations in the frequency domain) as discussed in **Annex B** have been used for the measurements.

4.3 Test procedure

One measurement campaign conducted in Germany tested 20 different DVB-T receivers (nine set-top boxes, five USB sticks, two mobile receivers and four television set integrated receivers), which are considered to be typical DVB-T receivers on the German market, against LTE interference in a Gaussian, a static Rayleigh and a time-variant Rayleigh (for only six receivers) transmission channels.

Another measurement campaign conducted in Germany tested 19 different receivers available on the German market, amongst them five set-top boxes, eleven iDTVs, two SCART receivers and one portable receiver (with integrated 7" screen). These tests were performed under a Gaussian transmission channel environment.

In France, measurements on 24 different receivers (10 Silicon-tuners and 14 can-tuners³) were carried out under a Gaussian transmission channel environment. The receivers tested are either Integrated TV (iDTV) or Set Top Boxes (STB) since these equipments corresponding to fixed reception are considered to be more exposed to interference when mobile networks will be deployed.

In UK, measurements were made on 3 can-tuner devices and 2 silicon-tuner iDTV receivers.

Receiver manufacturers tested four receivers with silicon tuners and nine receivers with conventional can tuners. All receivers use tuners designed for cost effective high volume mass production.

The DVB-T receiver signal-to-interference ratios (C/I) were measured, in the presence of a LTE interfering signal, at different wanted signal levels. The objective was to evaluate the receiver PR and O_{th} . Setting the wanted signal at relatively high levels permitted feeding into the receiver under test stronger interfering signals than those fed into it at lower wanted signal levels. In principle, C/I measured at C_{ref} (reference sensitivity level) are 3 dB higher than those

³ It has to be noted that in 4 cases, the technology was assumed but not confirmed by the manufacturer.

measured at higher wanted signal levels. When the measurements are conducted at a wanted signal level close to receiver noise floor, the impact of receiver noise on measurement results is not negligible. Consequently, at wanted signal level close to receiver sensitivity, noise should be taken into account, e.g. at sensitivity + 3dB, 3 dB should be added to the PR.

The test set-ups used in different measurement campaigns are given in **Annex C**.

4.3.1 Measurements under static conditions

Receiver sensitivity as well as protection ratio were determined to ensure the absence of picture failure during a minimum observation time of 30 s. The wanted and interfering signal levels were measured at the receiver input as the rms power in a Gaussian channel. Measurement results were noted as C/I.

4.3.2 Time varying interference source signals

Although TPC is foreseen in LTE implementation, measurements under these conditions were not undertaken. However, some dynamic measurements based on other effects than TPC were conducted for LTE-UE signals.

LTE-UE signals used for most of the measurements were of a pulsed nature. The time variance of one of the signals, measured with a spectrum analyzer with zero span, is shown in Figure 3. The interferer power I , as used in PR calculations (C/I), is the root-mean-square (rms) power during the active time (pulse time). See also **Annex B** for further details.

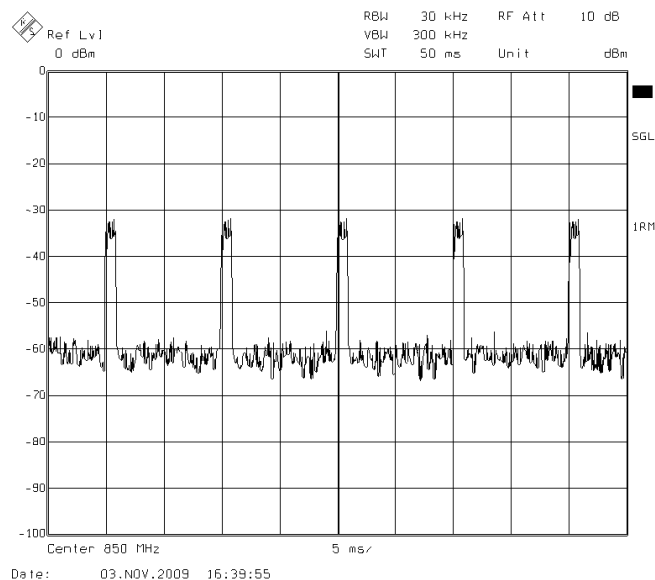

Figure 3: Time variance of the LTE UE Signal

4.3.3 Measurements in a time variant Rayleigh transmission channel for the wanted DVB-T signal

The time-variant Rayleigh transmission channel is the most realistic one for portable DVB-T reception, even when the receiving antenna stays in a fixed position. In this channel the antenna receives many small and uncorrelated reflected and refracted waves, but no direct wave from the transmitter. The small waves have time-variant amplitude and phase values, due to continuously changing transmission conditions. A transmission channel that simulates portable reception in an urban area very well is the so called “Typical Urban” transmission channel, the TU 12 Path 0.4 km/h. The Rohde & Schwarz SFQ TV-generator simulates with 12 paths a mobile reception at a velocity of 0.4 km/h. The PR with a LTE-UE signal as interferer was measured for DVB-T receivers using this channel profile for the wanted DVB-T signal.

4.4 Receiver types

A fundamental design strategy of receiver manufacturers is to reduce the number of individual (discrete) components, ideally down to few pieces. Each receiver design is driven by several aspects including physical dimensions, costs and technical performance with respect to its envisaged main usage (in a static environment or in a time-varying – portable, mobile – channel), expected echo situations, interactions within the same device (e.g. in mobiles).

The first block in a receiver dealing with incoming RF signals is the tuner. It has to select and amplify the desired TV channel within a very wide spectrum, in case of DVB-T ranging from 174 to 862 MHz (according to specifications), to reject all other signals (e.g. TV channels in band, but also many other signals out-of-band) and down-convert the desired signal to an intermediate frequency (IF) for the demodulator.

Tuner modules must be designed to address the different channel bandwidths (typically 6, 7 or 8 MHz) in addition to different analogue TV waveform standards (e.g. NTSC, PAL, SECAM) and digital signals. Major blocks inside a tuner are input filter, amplifier, mixer (with oscillator) and IF amplifiers (including filters).

In general there are four different types of tuners:

- Traditional can-type tuners

Such tuners have been implemented over the last decades as a module consisting of about 100-200 passive and active components mounted on a small circuit board inside a metal shield enclosure. This tuner manufactured by a variety of vendors uses the superhet principle, by mixing down the desired channel to the intermediate frequency, defined by the programmed oscillator frequency. Discrete IF amplifiers and filters further boost the signal and reject unwanted signal and noise. Front-end filtering and amplification is realized by two or three parallel filter/amplifier sections, one of which is selected depending on the frequency of the desired channel.

The hardware-based (LC or SAW) filters inside a can tuner module are fixed in bandwidth and signal-handling capability making a flexible multi-standard design impossible.

- Double-super silicon tuners using an up-down conversion

The first IF is above the wanted band, usually at about 1.2 GHz, the second IF like for traditional tuners at about 36 MHz. This minimizes the $n+9$ problem. However, these tuners need two SAW filters that increase considerably the costs.

- Homodyne silicon tuners

These tuners convert the signal down to an IF of 0 Hz in a single step. Advantages are simplified filtering (no SAW filters are needed) and amplification.

- Low-IF silicon tuners

These so-called supradyne-tuners convert the signal down to an IF of about 3 to 5 MHz (typically 4 MHz) in a single step. No additional SAW filters are needed.

There are no normalized “classes of devices” where the above mentioned tuners types are integrated. Any decision for a certain type or even model is always a compromise between performance, space the device requires and costs.

Silicon tuners have inherent advantages over traditional shielded discrete implementations:

- Lower power consumption
- Flexibility for addressing the global market with a single solution, leading to economies of scale
- Consistent performance and quality (tighter production tolerances)
- Lower manufacturing costs (at all phases of production)

Smaller size (form factor), thus reducing device size. This includes easy and cheap implementation of multiple tuners, e.g. for diversity applications, picture-in-picture and PVR-applications.

5 PROTECTION RATIOS

The protection ratios presented in this section have been normalised to 64-QAM 2/3 DVB-T 8 MHz bandwidth system variants in static (Gaussian channel) and time-varying (Rayleigh channel) reception conditions using the values in the RRC-06 Final Acts. In order to obtain protection ratios for different system variants and for different reception conditions the correction factors given in Table 4 (copy of Table A.4.4-15 of the RRC-06 Final Acts) should be used. Noting that these correction factors, which were obtained on the basis of C/N measurements (i.e. the propagation channel was applied to the wanted signal only), are relative to 64-QAM 2/3 DVB-T, they need to be adjusted (normalized to a corresponding system variant) before being added to other protection ratios, e.g. for DVB-T 16-QAM 2/3 and 64-QAM 3/4.

DVB-T system variant	Gaussian channel	Fixed reception	Portable outdoor reception	Portable indoor reception	Mobile reception
QPSK 1/2	-13.5	-12.5	-10.3	-10.3	-7.3
QPSK 2/3	-11.6	-10.5	-8.2	-8.2	-5.2
QPSK 3/4	-10.5	-9.3	-6.9	-6.9	-3.9
QPSK 5/6	-9.4	-8.1	-5.6	-5.6	-2.6
QPSK 7/8	-8.5	-7.1	-4.5	-4.5	-1.5
16-QAM 1/2	-7.8	-6.8	-3.6	-3.6	-0.6
16-QAM 2/3	-5.4	-4.3	-2.0	-2.0	1.0
16-QAM 3/4	-3.9	-2.7	-0.3	-0.3	2.7
16-QAM 5/6	-2.8	-1.5	1.0	1.0	4.0
16-QAM 7/8	-2.3	-0.9	1.7	1.7	4.7
64-QAM 1/2	-2.2	-1.2	1.0	1.0	4.0
64-QAM 2/3	0.0	1.1	3.4	3.4	6.4
64-QAM 3/4	1.6	2.8	5.2	5.2	8.2
64-QAM 5/6	3.0	4.3	6.8	6.8	9.8
64-QAM 7/8	3.9	5.3	7.9	7.9	10.9

Note: Measurements of IMT BS interference into DVB-T reception for Gaussian and time-variant Rayleigh channels indicate that the correction factors of Table 4 for mobile reception are more appropriate also for portable reception than those given in Table 4 for portable reception. It is therefore recommended to use the correction factors for mobile reception for both portable and mobile reception.

Table 4: Correction factors for protection ratios (dB) for different system variants relative to 64-QAM 2/3 DVB-T signal and for different reception conditions interfered with by other primary services

The overloading thresholds are assumed to be independent from the reception conditions, also understanding that no mast heads-end amplifiers and active antennas are used.

Due to recognized performance differences of different receiver types and technologies, the protection ratios and overloading thresholds presented in the tables are provided for three categories:

- Can-type tuners implemented in set-top boxes and/or integrated TV (iDTV);
- Silicon-type tuners implemented in set-top boxes and/or integrated TV (iDTV);
- Silicon-type tuners implemented in small USB-type devices, e.g. USB sticks.

There are a few mitigation techniques, which might be applied in order to protect DVB-T reception from LTE interference, and some are listed in **Annex 4** of CEPT Report 30 [4]. Some of these mitigation techniques were studied with respect to their suitability and efficiency in domestic environment (see **Annex E** for details).

It needs to be noted that PR measurements presented in this report were conducted for both 5 MHz and 10 MHz LTE signal bandwidth. The impact of the LTE signal bandwidth on measured protection ratios was found to be of the same

order of magnitude as the margin of error introduced by the statistical analysis employed to harmonise the results obtained in different measurement campaigns (see **Annex F** for some examples).

In view of the two different LTE signal bandwidths (5 MHz and 10 MHz) considered in the measurements, the frequency separation between the channel edges of the wanted and interfering signals is used instead of the frequency offset between the central frequencies of wanted and interfering signals. Figure 4 illustrates some examples of the relationship between the channel edge separation and the frequency offset.

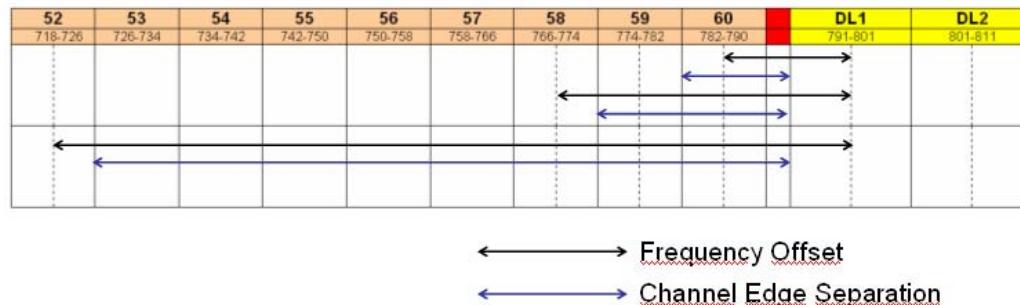

Figure 4: Frequency offset and channel edge separation for 10 MHz LTE signal

The protection ratio for a frequency offset of plus 65 MHz corresponds to the spurious response at the image frequency.

The following notes need to be consulted when using the values provided in the tables:

Note 1: PR is applicable unless the interfering signal is above the corresponding O_{th} . If the interfering signal level is above the corresponding O_{th} , the receiver will behave in a nonlinear way.

Note 2: At wanted signal level close to receiver sensitivity, noise should be taken into account, e.g. at 3 dB above receiver sensitivity threshold, 3 dB should be added to the PR.

Note 3: PR for different system variants and various reception conditions can be obtained using the correction factors in Table 4. The overloading threshold is independent of system variant and reception conditions.

Note 4: Treatment of overloading threshold in calculations when assessing interference from LTE into DVB-T is presented in **Annex C** to ECC Report 138.

Note 5: Using statistical analysis (assuming a Gaussian cumulative distribution) the 10th, 50th, and 90th percentile of all measured protection ratios and the 10th, 50th, and 90th percentile of all measured overloading thresholds for LTE interference into DVB-T were calculated. The information on the number of receivers used in this statistical analysis is provided in **Annex D**.

Note 6: The 90th percentile for the protection ratio value corresponds to the protection of 90% of receivers measured, with respect to the given frequency offset and parameter; whereas the 90th percentile for the overloading threshold value corresponds to overloading of 10% of receivers measured (i.e. the 10th percentile for the overloading threshold should be used to protect 90% of receivers measured).

Note 7: In some measurements of protection ratio from LTE UE, the ACLR of the interference signal was 70 dB, corresponding to a protection ratio of roughly -60 dB. Therefore, the actual protection ratio may be better than measured where the protection ratio is approaching this value.

Annex G contains references to the source documents of all protection ratio measurements provided for the development of this report.

5.1 LTE Base Station interfering signal

The protection ratios and overloading thresholds obtained for LTE-BS interferer are listed in Table 5a and Table 5b, respectively, for different receiver types and tuner technologies.

DVB-T PR for 64-QAM 2/3 DVB-T signal (LTE BS, Constant Average Power)									
Channel edge separation (MHz)	PR (dB)								
	10 th			50 th			90 th		
	Can STB/iDTV	Silicon STB/iDTV	Silicon USB	Can STB/iDTV	Silicon STB/iDTV	Silicon USB	Can STB/iDTV	Silicon STB/iDTV	Silicon USB
1	-43	-43	-42	-39	-37	-37	-33	-33	-33
9	-48	-46	-49	-46	-44	-45	-42	-40	-36
17	-51	-50	-48	-48	-46	-45	-39	-44	-36
25	-59	-54	-50	-58	-50	-46	-56	-48	-38
33	-66	-55	-49	-64	-51	-47	-63	-49	-42
41	-68	-56	-50	-59	-52	-46	-58	-50	-43
49	-70	-57	-51	-67	-53	-48	-66	-50	-43
57	-71	-58	-52	-68	-53	-48	-66	-51	-43
65	-57	-61	-50	-46	-52	-46	-39	-45	-44

Table 5a: DVB-T PR values in the presence of a time-constant LTE BS interfering signal in a Gaussian channel environment at the 10th, 50th and 90th percentile: comparison between can-tuners and silicon-tuners.⁴

DVB-T O _{th} for 64-QAM 2/3 DVB-T signal (LTE BS, Constant Average Power)									
Channel edge separation (MHz)	O _{th} (dBm)								
	90 th			50 th			10 th		
	Can STB/iDTV	Silicon STB/iDTV	Silicon USB	Can STB/iDTV	Silicon STB/iDTV	Silicon USB	Can STB/iDTV	Silicon STB/iDTV	Silicon USB
1	-1	-2	-3	-9	-8	-17	-13	-13	-26
9	3	4	0	-3	-1	-13	-8	-7	-22
17	4	7	0	-2	2	-7	-19	-6	-18
25	1	8	0	-8	4	-6	-13	-6	-14
33	1	6	0	-4	4	-5	-8	-6	-14
41	7	8	0	-2	3	-5	-6	-5	-14
49	9	5	0	0	1	-5	-5	-4	-14
57	9	5	0	1	1	-3	-5	-4	-13
65	8	6	0	2	2	-11	-3	-6	-16

Table 5b: DVB-T O_{th} values in the presence of a time-constant LTE BS interfering signal in a Gaussian channel environment at the 10th, 50th and 90th percentile: comparison between can-tuners and silicon-tuners.⁴

The difference of PR values for a Gaussian channel and for a time-variant Rayleigh transmission channel is given in Table 6 for six receivers measured assuming LTE-BS interference. It can be noted that the correction factors listed in Table 4 are between 3.2 dB and 4.2 dB for portable reception and between 6.2 dB and 7.2 dB for mobile reception (depending on system variant). A comparison of the measurement results with correction factors listed in Table 4 shows that the time-variant Rayleigh channel is closer described if the correction factors for the mobile reception listed in Table 4 are used.

⁴ The information on the number of receivers used to perform the statistical analysis is provided in Annex D.

		Channel edge separation (MHz)								
		1.5	9.5	17.5	25.5	33.5	41.5	49.5	57.5	65.5
Difference (dB) Gaussian – time-variant Rayleigh channel	Rx1	8.5	9.1	9.3	8.9	7.9	8.5	9	8.7	8.6
	Rx2	9	10.9	8.8	10.8	11	10.5	9.9	9.7	8.7
	Rx3	9.9	9.8	7.9	6.8	6.8	8	8.9	10	7.3
	Rx4	10.2	8.3	8.2	8.1	7.5	8.5	8.3	5.4	9.9
	Rx5	8.7	9.4	8.5	15.6	8.3	9.1	8.4	8.2	20.6
	Rx6	8.4	8.2	7.6	14.8	8.4	8.2	7.7	7.4	6.9
	\overline{Rx}	9.1	9.3	8.4	10.8	8.3	8.8	8.7	8.2	10.3

Table 6: Difference of PR values for Gaussian and time-variant Rayleigh channel for LTE BS interference into DVB-T 64QAM 2/3

5.2 LTE User Equipment interfering signal

The protection ratios and overloading thresholds obtained for LTE-UE interferer are listed in Table 7a and Table 7b, respectively, for different receiver types and tuner technologies. The range of values corresponds to different sequences (see **Annex B** for details) for the UE signals used in different measurements. Different sequences and different receivers show a spread in protection ratios and overload thresholds which is under investigation by industry.

The protection ratios for interference signals with constant average power and no frequency variation were generally much lower than those for time varying interference signals such as the pulsed LTE UE waveform. The overload threshold for interference signals with constant average power and no frequency variation were generally much higher than those for time varying interference signals such as the pulsed LTE UE waveform.

DVB-T PR for 64-QAM 2/3 DVB-T signal (LTE UE TPC off)									
Channel edge separation (MHz)	PR (dB)								
	10 th			50 th			90 th		
	Can STB/iDTV	Silicon STB/iDTV	Silicon USB	Can STB/iDTV	Silicon STB/iDTV	Silicon USB	Can STB/iDTV	Silicon STB/iDTV	Silicon USB
co-channel	13 ... 18	13 ... 18	NA	18 ... 19	18 ... 19	NA	20 ... 22	19 ... 22	NA
1.5	-28 ... -14	-15 ... -14	-28	-21 ... -13	-14	-23	-14 ... -12	-13	-18
9.5	-51	-51	-43	-48 ... -47	-49 ... -42	-37	-45 ... -42	-46 ... -32	-31
17.5	-56 ... -55	-54 ... -51	-45	-49 ... -48	-51 ... -43	-39	-43 ... -40	-48 ... -35	-32
25.5	-63 ... -59	-56 ... -55	-47	-61 ... -57	-52 ... -46	-39	-59 ... -54	-48 ... -36	-31
33.5	-70 ... -62	-57 ... -53	-49	-67 ... -56	-54 ... -45	-40	-63 ... -50	-51 ... -37	-31
41.5	-79 ... -63	-61 ... -52	-49	-73 ... -56	-53 ... -45	-40	-66 ... -49	-45 ... -38	-31
49.5	-76 ... -66	-60 ... -56	-49	-74 ... -57	-56 ... -48	-40	-71 ... -47	-51 ... -40	-30
57.5	-77 ... -66	-62 ... -55	-49	-78 ... -59	-55 ... -46	-40	-70 ... -52	-48 ... -37	-30
65.5	-63 ... -54	-63 ... -52	-47	-50 ... -44	-55 ... -45	-40	-38 ... -33	-47 ... -37	-32

Table 7a: DVB-T PR values in the presence of a LTE-UE interfering signal without TPC in a Gaussian channel environment at the 10th, 50th and 90th percentile: comparison between can-tuners and silicon-tuners.⁴

DVB-T O_{th} for 64-QAM 2/3 DVB-T signal (LTE UE TPC off)									
Channel edge separation (MHz)	O_{th} (dBm)								
	90 th			50 th			10 th		
	Can STB/iDTV	Silicon STB/iDTV	Silicon USB	Can STB/iDTV	Silicon STB/iDTV	Silicon USB	Can STB/iDTV	Silicon STB/iDTV	Silicon USB
1.5	-11 ... 2	-14 ... -9	-3	-16 ... -11	-16 ... -16	-15	-21 ... -19	-23 ... -17	-27
9.5	1 ... 7	-10 ... 9	-13	-6 ... -2	-28 ... 2	-30	-18 ... -4	-46 ... -5	-47
17.5	0 ... 7	-5 ... 12	-15	-16 ... -10	-26 ... 5	-32	-31 ... -26	-47 ... -2	-49
25.5	-7 ... -6	-5 ... 9	-18	-13 ... -9	-25 ... 2	-30	-19 ... -11	-44 ... -6	-42
33.5	-1 ... 0	-5 ... 10	-19	-9 ... -4	-24 ... 3	-30	-17 ... -7	-43 ... -5	-41
41.5	0 ... 9	-16 ... 7	-13	-9 ... -2	-25 ... 0	-25	-18 ... -7	-41 ... -7	-37
49.5	6 ... 11	-3 ... 13	-13	-3 ... 2	-21 ... 4	-25	-16 ... -3	-39 ... -5	-37
57.5	4 ... 10	-12 ... 11	-17	-4 ... 2	-21 ... 2	-28	-16 ... -3	-35 ... -7	-39
65.5	5 ... 10	-13 ... 8	-10	-2 ... 4	-23 ... -1	-25	-9 ... -3	-32 ... -10	-40

Table 7b: DVB-T O_{th} values in the presence of a LTE UE interfering signal without TPC in a Gaussian channel environment at the 10th, 50th and 90th percentile: comparison between can-tuners and silicon-tuners.⁴

The difference of PR values for a Gaussian channel and for a time-variant Rayleigh transmission channel is given in Table 8 for six receivers measured assuming LTE-UE interference. It can be noted that the correction factors listed in Table 4 are between 3.2 dB and 4.2 dB for portable reception and between 6.2 dB and 7.2 dB for mobile reception (depending on the system variant). A comparison of the measurement results with the correction factors listed in Table 4 shows that the time-variant Rayleigh channel is closer described if the correction factors for the mobile reception listed in Table 4 are used.

		Channel edge separation (MHz)								
		1.5	9.5	17.5	25.5	33.5	41.5	49.5	57.5	65.5
Difference [dB] Gaussian – time-variant Rayleigh channel	Rx1	7.5	6.2	5.5	5.2	6.3	6.4	6.4	6.4	6.3
	Rx2	9.8	7	7.8	8.5	7.7	7.7	9	9.5	8
	Rx3	8.1	9.1	10.5	11.9	12.3	11.1	14	9.3	6.4
	Rx4	7	9	7.5	9.2	8.8	6.7	8.5	7.3	8.4
	Rx5	7.8	5.8	6.1	3.1	0.4	1.5	-0.3	0.8	7.3
	Rx6	5.7	6.8	11	15	13.5	9.5	3	8.7	5.6
	$\overline{R_x}$	7.7	7.3	8.1	8.8	8.2	7.2	6.8	7.0	7.0

Table 8: Difference of PR values for Gaussian and time-variant Rayleigh channel for LTE UE interference into DVB-T 64QAM 2/3

6 CONCLUSION

This report presents the results of measurements to assess the performance of DVB-T receiver in terms of measured carrier-to-interference protection ratios and overloading thresholds in the presence of a single interfering LTE signal. In total, 81 DVB-T receivers (set top boxes, television set integrated receivers, USB sticks, mobile receivers available on the market in 2009), which are considered to be typical DVB-T receivers, have been tested against LTE interference in a Gaussian channel environment (6 receivers were measured also in a time-variant Rayleigh transmission channel). These receivers are implementing either conventional can-type tuners or silicon-based tuners. Interference in co-channel, first adjacent channel and beyond has been considered. Values for the measured protection ratios and overloading thresholds have been statistically calculated at the 10th, 50th and 90th percentile for all the receivers tested.

Amongst the most noticeable results is the wide range of performance of individual receiver depending on the nature of the LTE uplink signal. Some preliminary indications show that, amongst other, it may be related to the way the Automatic Gain Control of the DVB-T receiver is designed in some specific receivers. Industry is investigating further this matter.

The results may be used by administrations seeking to protect their broadcasting services from interference generated by LTE downlink or uplink transmissions in the band 790-862 MHz.

ANNEX A: METHOD TO DERIVE THE RECEIVER OVERLOADING THRESHOLD

The method used for determining protection ratios and overloading thresholds is composed of two steps:

1. The measured C(I) curve is approximated by a straight line with unity slope which represents the ideal linear behaviour of the receiver front-end (constant PR case). The protection ratio of the receiver is obtained by subtracting I from C(I) at any points on this line. The protection ratio obtained can be used for all wanted signal levels.
2. A strong deviation of the measured C(I) curve from the straight line with unity slope indicates where the interfering signal reaches the overloading threshold; i.e., the onset of strong non-linear behaviour. The deviated segment of C(I) curve is approximated by a line vertical to I-axis (constant I case). The value of I at the point of intersection between the straight line with unity slope and the line vertical to I-axis is considered to be the receiver overloading threshold ($I=O_{th}$).

This two step procedure is depicted in Figure A1.

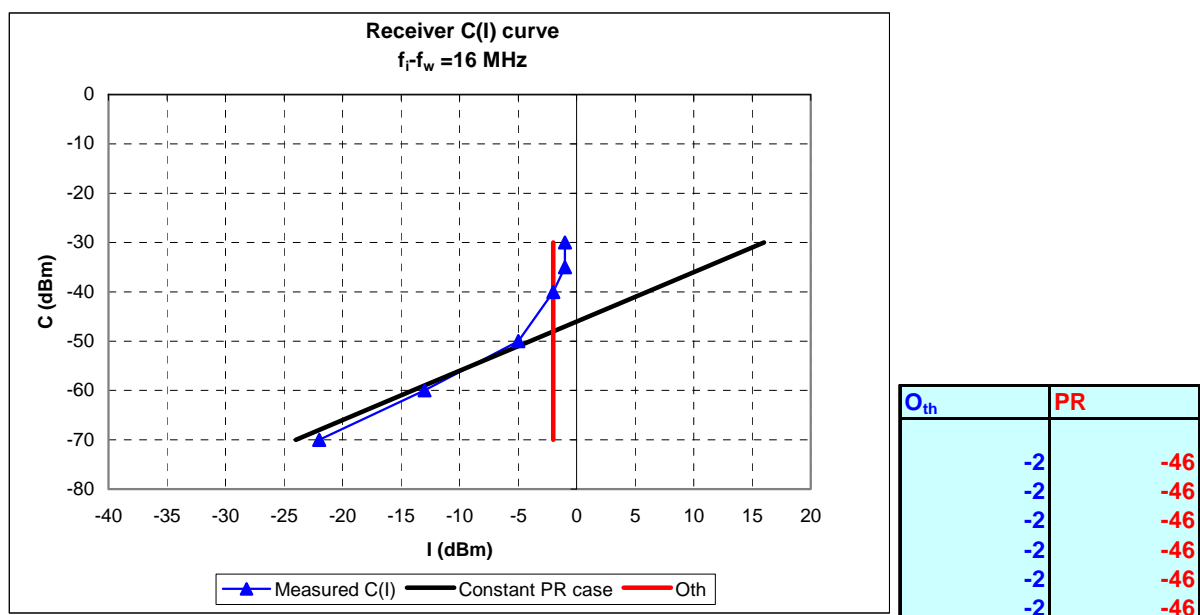

Figure A1: Determination of the receiver protection ratio and overloading threshold from its C(I) curve; PR = -46 dB, Oth = -2 dBm

In some cases the approximation of a measured C(I) curve by a straight line with unity slope and a line vertical to I-axis may seem not to be very straight forward, but it is always possible to do it with an acceptable approximation error that should be in favour of the victim receiver. Examples of approximations are given in the following figures.

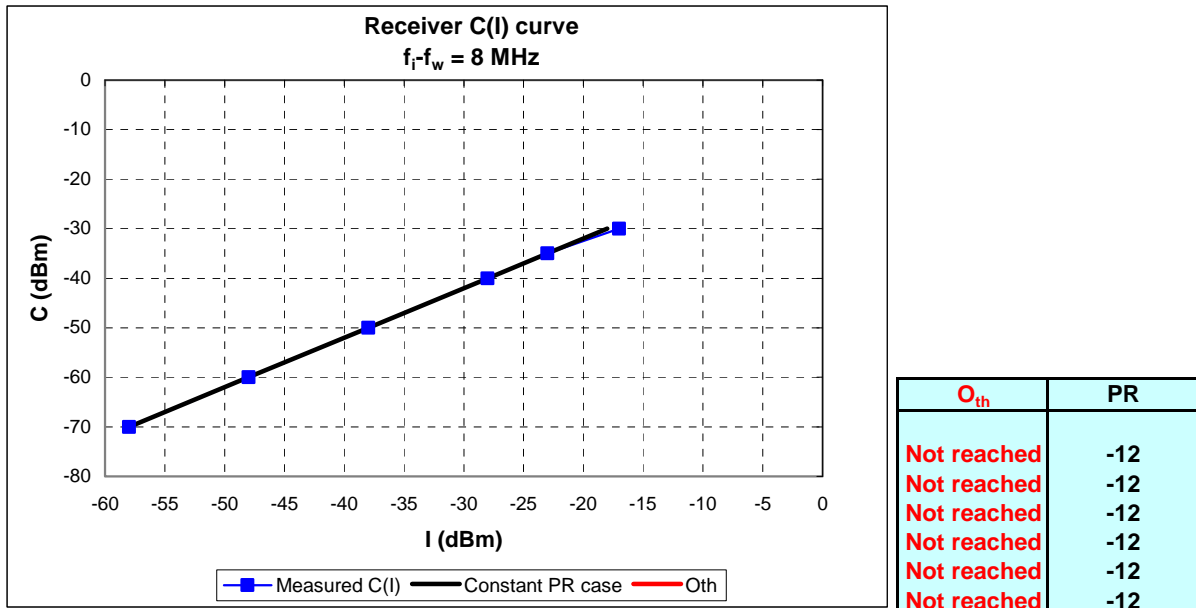

Figure A2: A well approximated C(I) curve; PR = -12 dB; overloading threshold is not reached

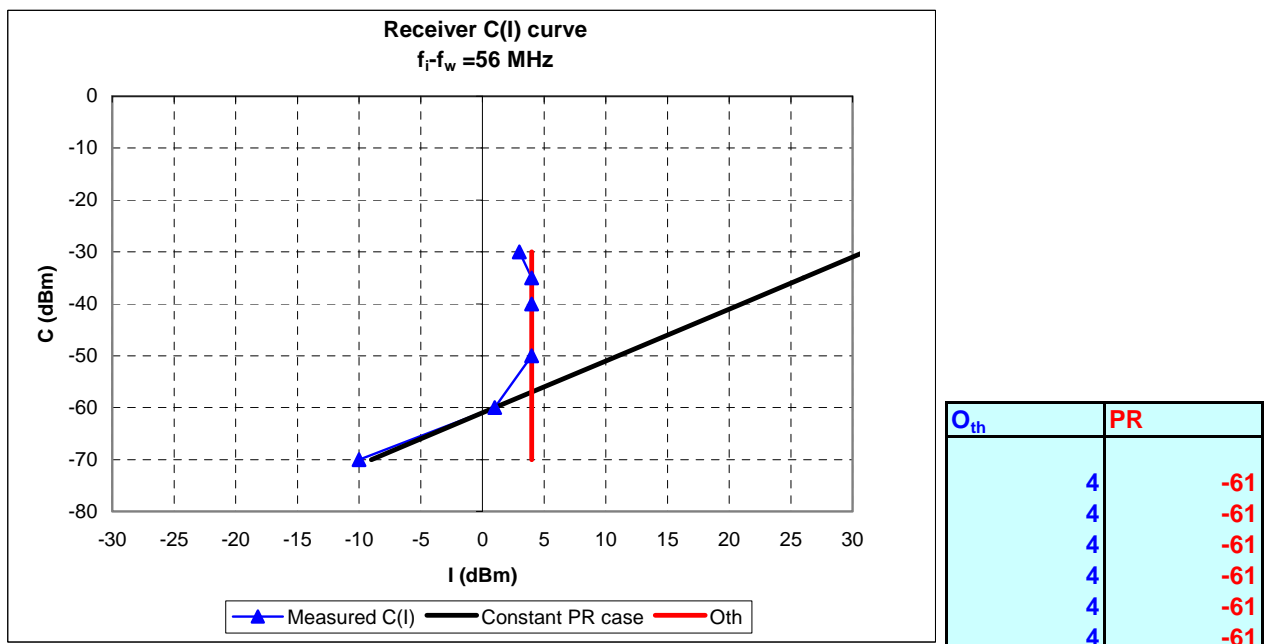

Figure A3: A well approximated C(I) curve; PR = -61 dB; Oth = 4 dBm

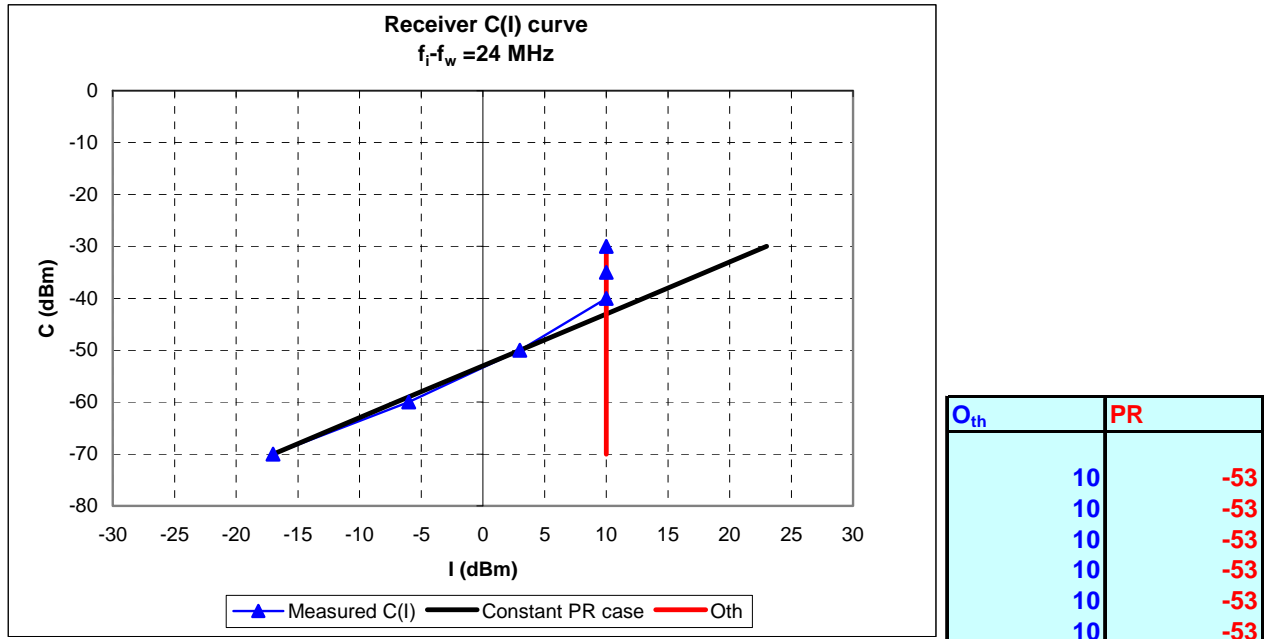

Figure A4: A well approximated C(I) curve; PR = -63 dB; Oth = 10 dBm

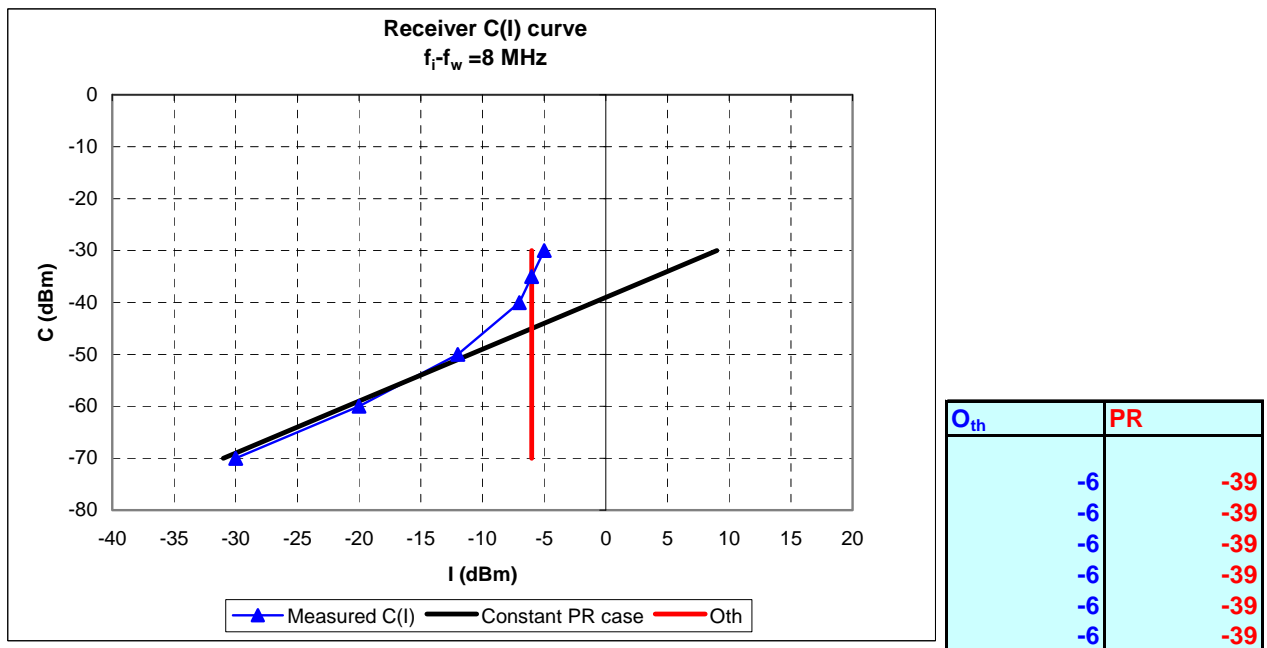
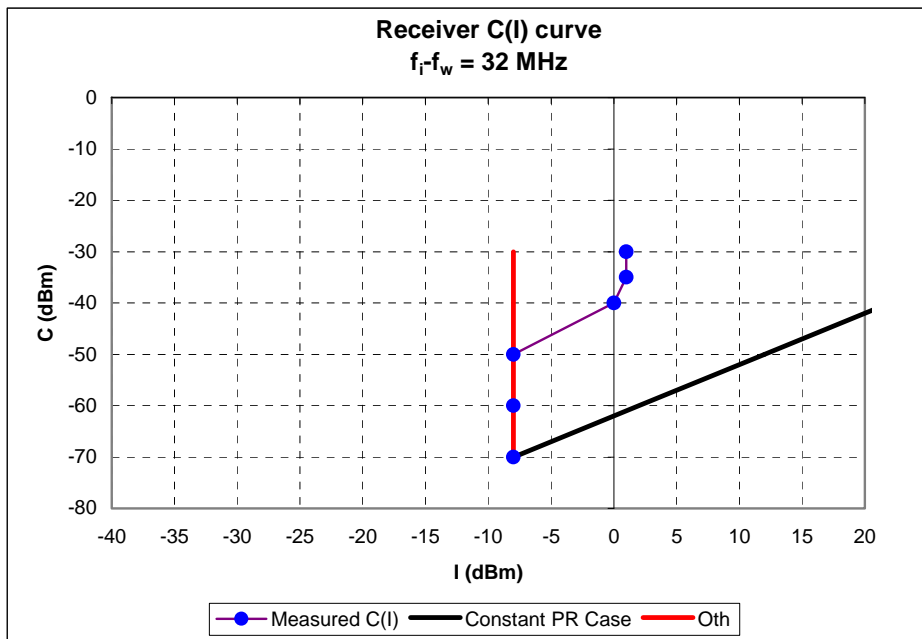
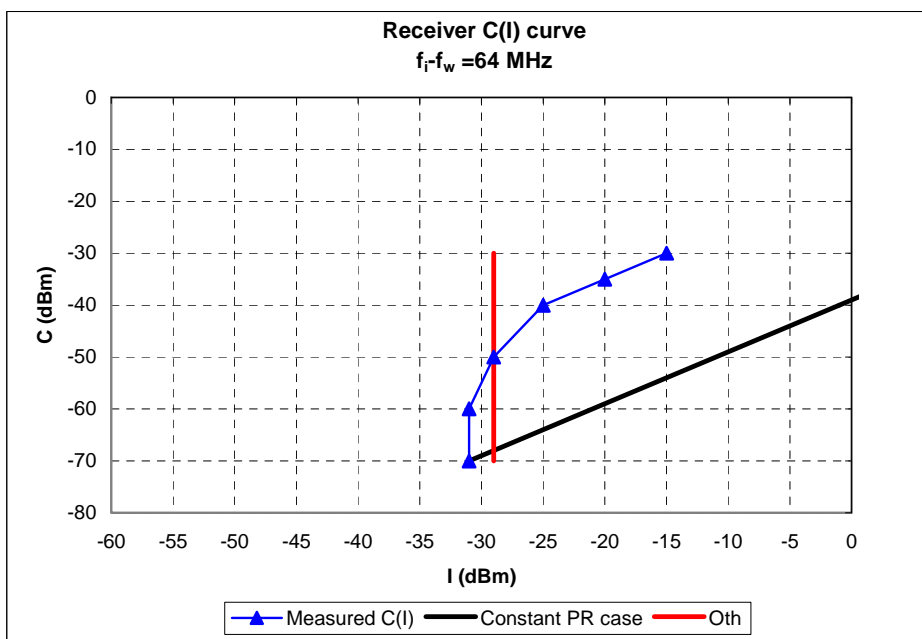

Figure A5: Some difficulties to determine the overloading threshold; PR = -39dB; Oth = -6 dBm



O _{th}	PR
-8	-62
-8	-62
-8	-62
-8	-62
-8	-62
-8	-62

Figure A6: A C(I) deviates from ideal behaviour; PR = -62 dB, Oth = -8 dBm



O _{th}	PR
-29	-39
-29	-39
-29	-39
-29	-39
-29	-39
-29	-39

Figure A7: C(I) strongly deviates from ideal behaviour; PR = -39 dB, Oth = -29dBm. Such non-linear behaviours were observed only in the presence of a LTE UE interfering signal (1 subF case)

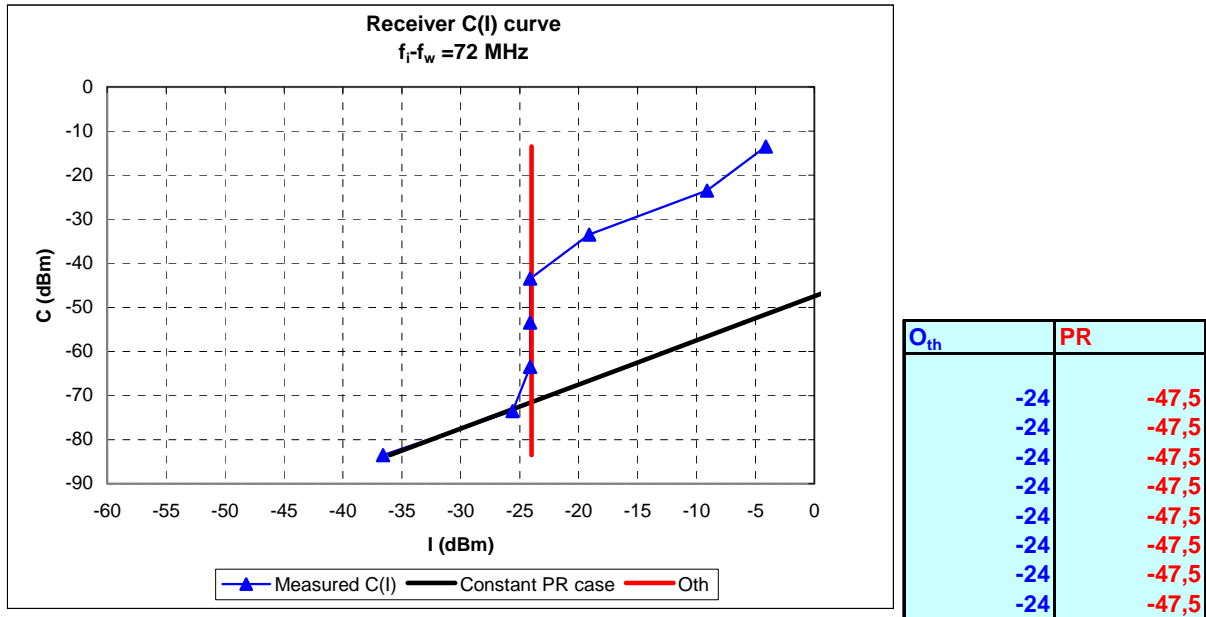

Figure A8: C(I) with recovery after an increase of 40 dB of the wanted signal level;
 PR = -47,5 dB, Oth = -24 dBm

ANNEX B: SEQUENCES USED FOR MEASUREMENTS ON LTE USER EQUIPMENT SIGNALS

Different LTE UE signal sequences were used for the measurements of LTE UE-signals, varying in time-domain as well as in frequency domain.

All sequences are based on a 5 MHz LTE channel configuration. A crest factor of about 7dB has been measured, but not monitored for each individual sequence. No transmit power control (TPC) was applied.

Two basic LTE UE patterns with respect to frequency domain were used:

1. Sequences where all 25 resource blocks (RB) are allocated.
2. Sequences where only one RB was allocated for each radio frame, and which was shifted for the next radio frame.

In addition, two general patterns were used for variations in time domain:

- a. Continuous sequences, i.e. all radio frames were used.
- b. "Pulsed" sequences, i.e. either unused sub-frames or even unused radio frames were inserted, in order to simulate phases of no transmission activity (Figure B1). The duration of this inserted "pause" varied between sequences used, but also within a certain sequence.

In the following, combinations of the above mentioned general patterns are described in detail, which were used in the different measurement campaigns.

Note: First measurements on an LTE UE prototype in a laboratory in Germany confirmed these variations. In addition, the signals measured there have shown variations with respect to the number of RB assigned, at least from Radio Frame to Radio Frame. In the measurements reported here, either all RB were assigned or only one.

All resource blocks were used and no variation in the time domain, i.e. the sequence is continuous (1.a.).

An example (measured) is shown in Figure B1.

Explanation of the figure: The left hand side of Figure B1 shows a measured spectrogram of this sequence, a so-called "waterfall diagram" of the signal. The x axis shows the frequency domain, the y axis the time domain (top = past). The signal level is displayed in different colours (black = noise, red = highest). The yellow trace on the right hand side, top, shows the signal level over entire channel bandwidth vs. time, the red curve below a momentary spectrogram. All markers correlate in all three windows.

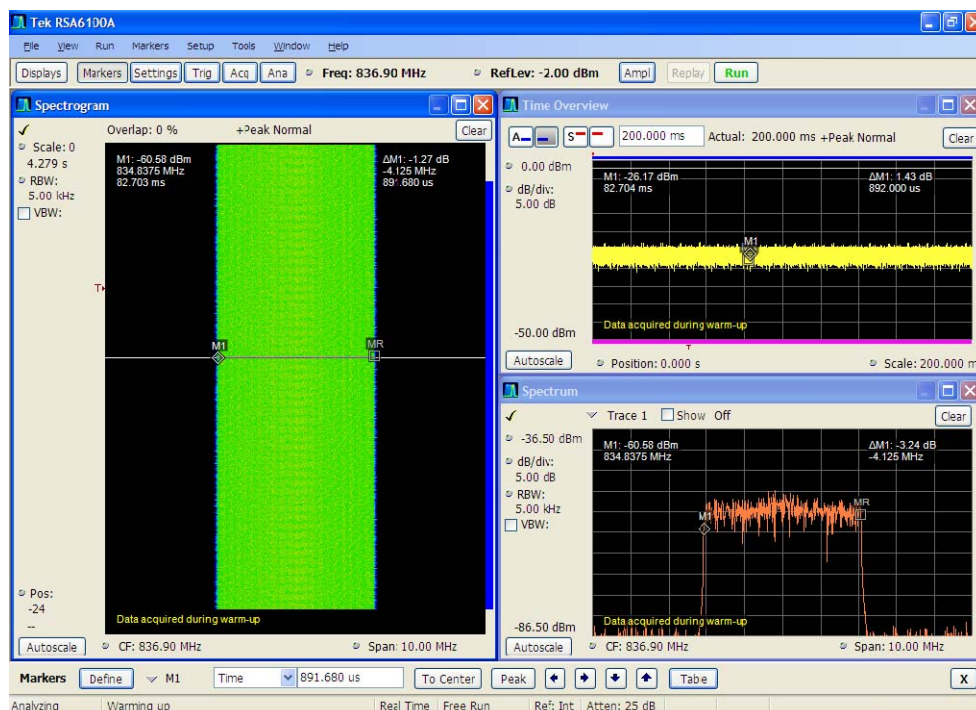

Figure B1: Illustration of sequence 1.a. – all resource blocks are used, continuous in time domain

All resource blocks were used, but “pulsed” (1.b., with 1ms signal and 9ms duration of no activity).

In this case, one sub frame in a radio frame used for traffic (1 ms out of 10 ms), all RBs in the subframe used, thus occupying the whole bandwidth. As a result the transmission power is pulsed with duty cycle 1/10.

The time variance of such a sequence, measured with a spectrum analyzer with zero span, is shown in Figure B2.

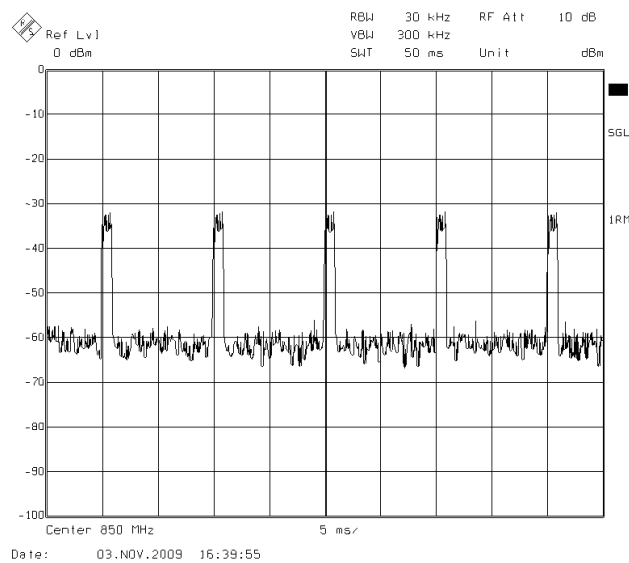

Figure B2: Time variance of the LTE UE Signal

One resource blocks used, but continuous signal (2.a.).

In this case, only one RB was assigned, but the signal was continuous. An example (measured) is shown in Figure B3 (same notes to explain figure apply than for Figure B1).

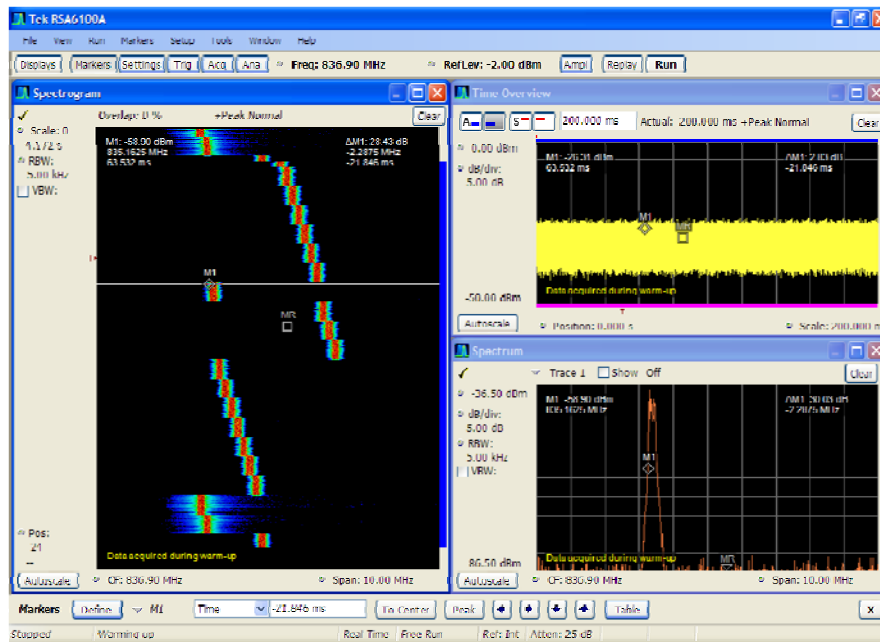

Figure B3: Illustration of sequence 2.a. – one RB used but varying in frequency domain; continuous in time domain

One resource blocks used, “pulsed” (2.b., with 230ms signal and varying duration of “no activity”).

Again, only one RB was assigned and several unused Radio Frames (“no activity” of the UE) were inserted, indicated by “xNRF” in the name of the sequence. A general sketch of such a sequence is shown in Figure B4.

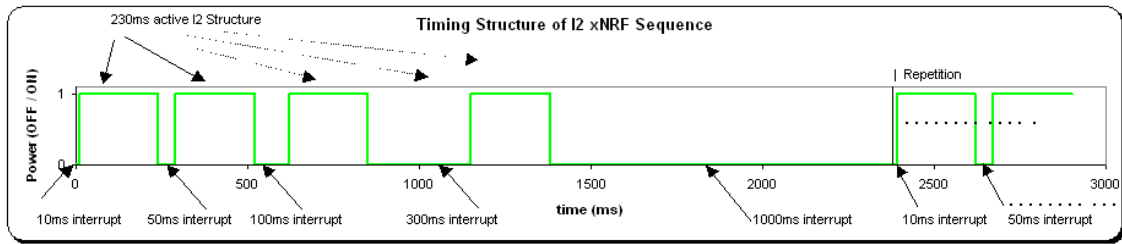

Figure B4: General sketch of the timing structure a sequence with one resource block and varying duration of “no activity”

ANNEX C: MEASUREMENT SET-UP

Generic measurement set-up used to assess DVB-T receiver performance in the presence of interference from LTE is given in Figure C1. Figure C2 shows an example of implementation of this generic set-up.

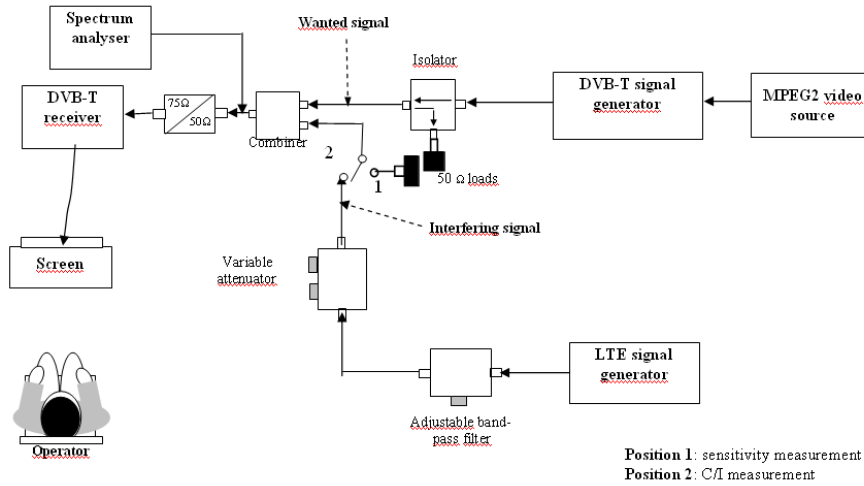

Figure C1: Generic measurement set-up

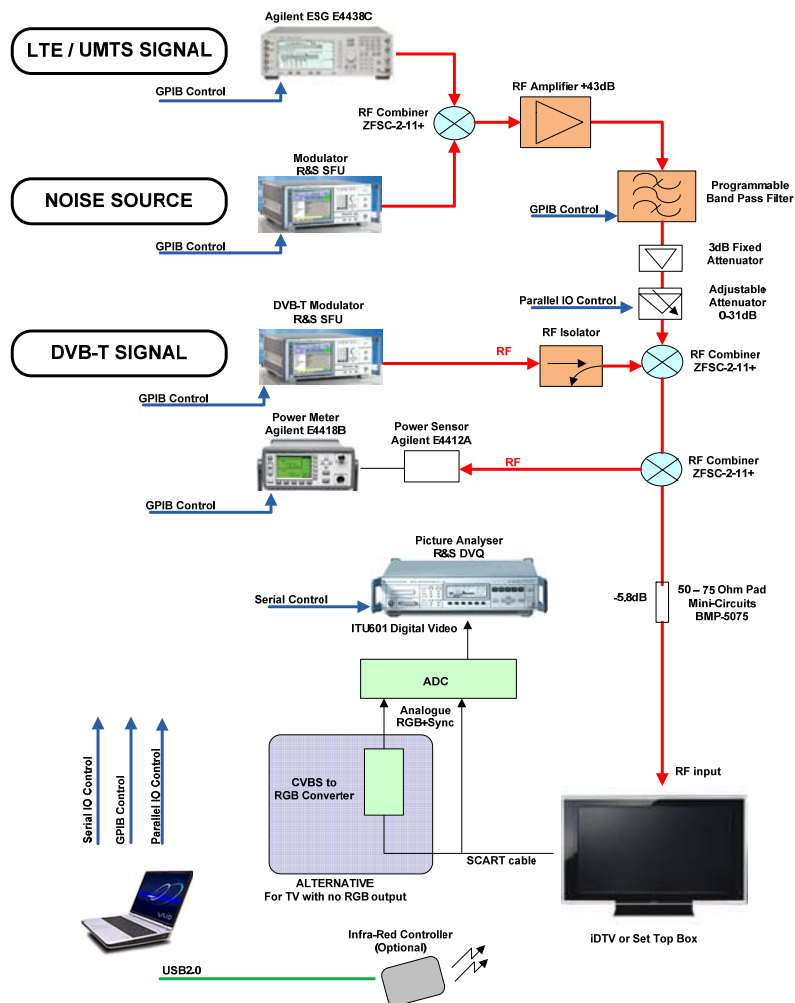

Figure C2: Test equipment setup for LTE interferer measurements (example)

ANNEX D: STATISTICS ON RECEIVERS

Table D1 and Table D2 provide information on the number of receivers used to derive the protection ratio values and overloading thresholds for Base Station and User Equipment interference, respectively.

Channel edge separation (MHz)	Can STB/iDTV	Silicon STB/iDTV	Silicon USB
1	34	14	7
9	34	14	7
17	34	14	7
25	22	6	7
33	22	6	7
41	22	6	7
49	22	6	7
57	22	6	7
65	34	14	7

Table D1: Number of receiver used in Base Station interference measurements for different receiver types and technologies

Channel edge separation (MHz)	Can STB/iDTV	Silicon STB/iDTV	Silicon USB
co-channel	6	6	9
1.5	19	4	9
9.5	19	4	9
17.5	19	4	9
25.5	19	4	9
33.5	19	4	9
41.5	31	10	9
49.5	19	4	9
57.5	31	10	9
65.5	31	10	9

Table D2: Number of receiver used in User Equipment interference measurements for different receiver types and technologies

ANNEX E: STUDIES ON POSSIBLE TECHNIQUES TO MITIGATE INTERFERENCE FROM LTE IN THE DOMESTIC ENVIRONMENT

Potential interference mitigation techniques, which may be considered by national administrations to solve or minimize the interference cases between the mobile services and terrestrial broadcasting on a local / regional / national basis, are listed and discussed in CEPT Reports 21 [5] (Section 3.1.2.5), 22 (Annex A5), 23 (Annex A1), 30 (Annex 4).

This annex provides information on attempts to test some examples of mitigation techniques considered in the domestic environment in the reports above, which were made within one measurement campaign contributed to the results presented in this report.

(1) The conducted LTE BS interference measurements with an additional filter in the receiver input lead showed an improvement of 20 dB in the protection ratio, for a wanted power of -70 dBm and a frequency offset of 20 MHz between wanted and unwanted carrier centre frequencies. This improvement reduced with increased wanted signal strength to approximately 10 dB for wanted signal levels between -30 dBm and -12 dBm.

It is noted, however, that any additional filter will have a certain insertion loss for frequencies over the receiving bandwidth, mainly for higher frequencies being closer to the cut-off frequency the filter has been designed for. The amount of losses depends on several factors, e.g. filter design and costs. From measurements on prototypes, it can be expected that these losses will be in the order of a few dB at least for channels 55 to 60, and that a gain in protection of about 20 dB is possible, at least for larger offsets between wanted and interfering signals.

(2) The results for the different types of receivers connected via an aerial distribution amplifier indicate that the main source of cable pick-up interference in this case can be attributed to the simple 1 or 2 m fly-lead. Replacing the fly-lead or TV aerial coaxial cable with a better quality shielded cable can give a 21 to 24 dB improved margin thus substantially reducing or curing completely the problem of cable amplifier pick-up interference.

ANNEX F: INFLUENCE OF THE LTE SIGNAL BANDWIDTH ON THE PROTECTION RATIO

To assess the influence of the LTE-BW change from 5 MHz to 10 MHz on the PR values, PRs were measured for two receivers, one with can tuner and one with silicon tuner, with LTE-BS and LTE-UE as interferer, having successively the two BW values.

The LTE signal has the same out of band emission for both BWs, as shown in Figure F1 and Figure F2 for the LTE-BS signal.

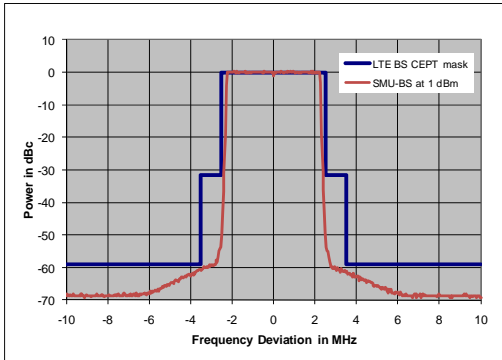

Figure F1: LTE-BS signal spectrum at 5 MHz channel bandwidth and spectrum emission mask

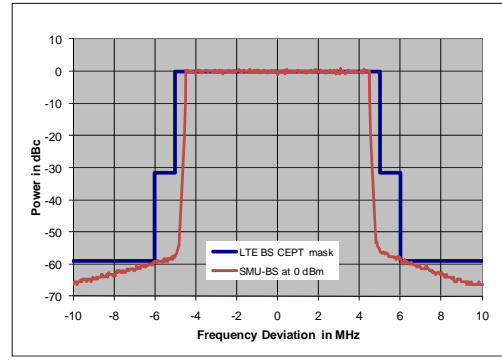

Figure F2: LTE-BS signal spectrum at 10 MHz channel bandwidth and spectrum emission mask

The PR measurement results are shown in Figure F3 and Figure F4 for the LTE-BS signal and in Figure F5 and Figure F6 for the LTE-UE signal.

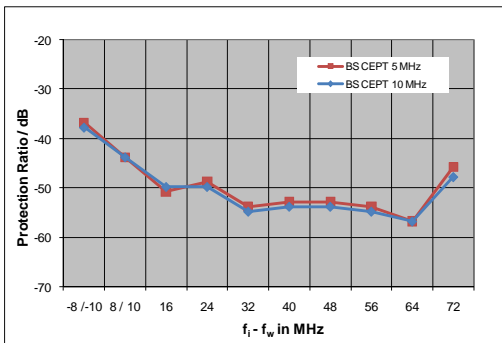

Figure F3: PR for LTE-BS as interferer in a static Rayleigh transmission channel, “can-tuner” receiver

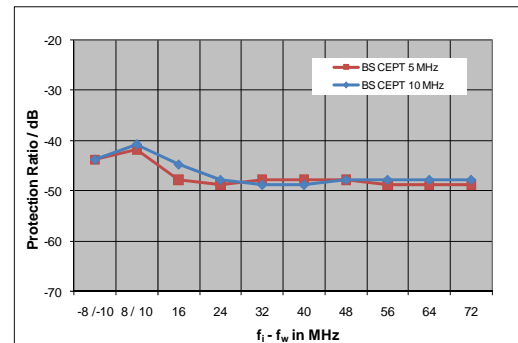

Figure F4: PR for LTE-BS as interferer in a static Rayleigh transmission channel, “silicon-tuner” receiver

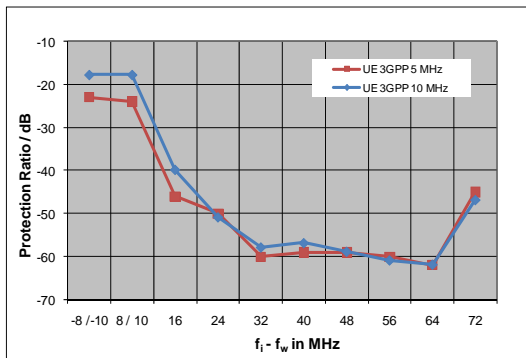

Figure F5: PR for LTE-UE as interferer in a static Rayleigh transmission channel, “can-tuner” receiver

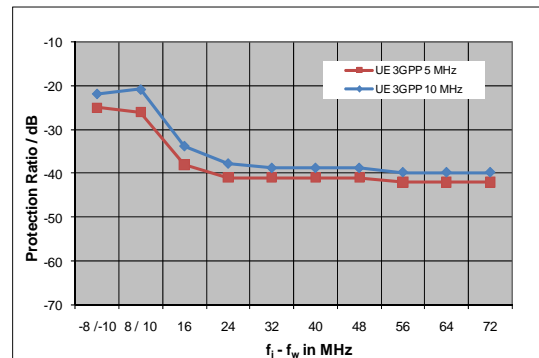

Figure F6: PR for LTE-UE as interferer in a static Rayleigh transmission channel, “silicon-tuner” receiver

For the LTE-BS signal as interferer, the BW has very little influence on the PR values. The differences are mostly within ± 1 dB.

For the LTE-UE signal as interferer, the BW has some influence on the PR values especially in the adjacent channels $N\pm 1$ and $N+2$. Here the PR for the 10 MHz interferer is 4 to 6 dB higher than for the 5 MHz interferer. In the adjacent channels $N+3$ to $N+9$ the PR increase with the BW is only 1 to 3 dB.

Conclusion

The LTE signal BW change from 5 MHz to 10 MHz increases the PR values significantly only for the UE case and only in the adjacent channels $N\pm 1$ and $N+2$, by 4 to 6 dB.

It is noted that these results may differ from the case of a dynamic change of the occupied bandwidth, e.g. if different numbers of RB are assigned to a terminal (UE).

ANNEX G: SOURCE DOCUMENTS OF PROTECTION RATIO MEASUREMENTS

Protection ratio measurements provided for the development of this report can be found in the following documents:

Document TG4(10)312: “Measurements of the performance of DVB-T receivers (protection ratio and overloading threshold) in the presence of interference from LTE signal” (contributed by France);

Document TG4(10)317: “UK measurements of LTE into DVB-T” (contributed by UK);

Document TG4(10)318: “Summary of conducted measurements on DVB-T interfered with by LTE uplink signals” (contributed by Media Broadcast GmbH);

Document TG4(10)322: “Protection ratios for LTE-BS and LTE-UE interference into DVB-T” (contributed by IRT);

Document TG4(10)327 + Appendixes A, B, C: “Measurements of protection ratios and overload thresholds on DVB-T receivers under interference from LTE or DVB-T in other channels” (contributed by Sony, Philips, Panasonic, NXP and LG);

ANNEX H: LIST OF REFERENCES

- [1] ECC Report 138: Measurements on the performance of DVB-T receivers versus mobile systems
 - [2] ITU-R Recommendation V.573-5: Radiocommunication vocabulary (www.itu.int)
 - [3] 3GPP TS 36.101 V8.5.1 “User Equipment (UE) radio transmission and reception”
 - [4] CEPT Report 30: The identification of common and minimal (least restrictive) technical conditions for 790 – 862 MHz for the digital dividend in the European Union
 - [5] CEPT Reports 21: Compatibility between “cellular / low power transmitter” networks and “larger coverage / high power / tower” networks
-