



Electronic Communications Committee (ECC)
within the European Conference of Postal and Telecommunications Administrations (CEPT)

ECC RECOMMENDATION (02)06 (revised June 2007 and May 2011 and June 2015)

**CHANNEL ARRANGEMENTS FOR DIGITAL FIXED SERVICE SYSTEMS
OPERATING IN THE FREQUENCY RANGE 7125-8500 MHz**

Recommendation adopted by the Working Group "Spectrum Engineering" (WGSE)

“The European conference of Postal and Telecommunications Administrations,

considering

- a) that CEPT has a long term objective to harmonise the use of frequencies throughout Europe to benefit from technical and economic advantages;
- b) that the preferred channel arrangements are one of the important factors in achieving the most effective and efficient use of spectrum by the Fixed Service (FS) systems;
- c) that a wide variety of digital FS applications may operate in the frequency range 7125-8500 MHz, which is allocated, without discontinuity, to the FS;
- d) that in accordance with the Joint NATO Frequency Agreement (NJFA), parts of the frequency range 7125-8500 MHz are used for military satellite communications and fixed service links;
- e) that the military requirements leave sufficient freedom for CEPT administrations to find on a national basis sharing arrangements for the introduction of civil FS systems in the frequency range 7125-8500 MHz;
- f) that according to the above considering's d) and e) in many CEPT countries the whole range 7125-8500 MHz may not be completely available for civil FS applications;
- h) that, when very high capacity links are required, further economy may be achieved using wider channel bandwidth associated to high efficient modulation formats;
- i) that due to the particular national allocation in this frequency range (civil and military), CEPT countries, currently using different arrangements than those recommended below, may not be able to implement this Recommendation.¹

recommends

- 1) that CEPT administrations, considering the introduction of new channel arrangements in any portion of the frequency range 7125-8500 MHz, or planning to re-structure their existing channel arrangements in this frequency range, should consider the channel arrangements options shown in Annexes 1 or 2 (Note 1);
- 2) that CEPT administrations planning to use, or restructuring, the frequency range 7725 MHz to 8275 MHz should refer to the arrangement in Annex 1.2.1 based on 28 MHz channels. CEPT administrations using channel arrangements in Annex 1.2.2 based on the 29.65 MHz raster provided by Recommendation ITU-R F.386, are encouraged, in the future, to migrate to the 28 MHz channel arrangement.
- 3) that CEPT administrations may consider merging any of the two adjacent 28 (or 29.65 where appropriate) MHz channels specified in Annex 1 and Annex 2 to create 56 (or 59.3 where appropriate) MHz channels, with centre frequency lying in the central point of the frequency separation between the merged channels.

¹ See also ECC Report 163 for further information.

The use of these merged channels may be subject to minimum bit rate obligations. To assist international co-ordination, administrations may refer to the channel identifiers described in Annex 3.

Note 1: Annexes 1 and 2 show two sets of channel arrangements for covering the whole frequency range 7125-8500 MHz when, for civil FS applications, only portions of this range are used, arrangements from both Annexes may be chosen as appropriate.

Note:

Please check the ECO web site (<http://www.cept.org/eco>) for the up to date position on the implementation of this and other ERC and ECC Recommendations.

Annex 1
First optional set of channel arrangements for covering the whole range 7125-8500 MHz

The frequency range is covered by four contiguous arrangements according the following generic scheme:

Frequency bands (MHz)			
7125 - 7425	7425 - 7725	7725 - 8275	8275 - 8500
1st band Arrangement	2nd band Arrangement	3rd band Arrangement	4th band Arrangement

1.1 PREFERRED CHANNEL ARRANGEMENTS IN THE 1st and 2nd FREQUENCY BANDS 7125-7425 MHz and 7425-7725 MHz

Let:

- f_0 – be the centre frequency of the band of frequencies occupied (MHz),
- f_n – be the centre frequency of a n -th radio-frequency channel in the lower half of the band (MHz),
- f'_n – be the centre frequency of a n -th radio-frequency channel in the upper half of the band (MHz).

The whole of the frequency band 7125-7725 MHz is being divided into 2 frequency bands with the centre frequencies:

- $f_0 = 7275$ MHz, for the 1st band 7125-7425 MHz;
- $f_0 = 7575$ MHz, for the 2nd band 7425-7725 MHz

Then the centre frequencies (MHz) of individual channels are expressed by the following relationships:

- a) for channel spacing of 28 MHz:
 - lower half of the band: $f_n = f_0 - 161 + 28 \cdot n$,
 - upper half of the band: $f'_n = f_0 - 7 + 28 \cdot n$, where $n = 1, 2, \dots, 5$;
- b) for channel spacing of 14 MHz:
 - lower half of the band: $f_n = f_0 - 154 + 14 \cdot n$,
 - upper half of the band: $f'_n = f_0 + 14 \cdot n$, where $n = 1, 2, \dots, 10$;
- c) for channel spacing of 7 MHz:
 - lower half of the band: $f_n = f_0 - 150.5 + 7 \cdot n$,
 - upper half of the band: $f'_n = f_0 + 3.5 + 7 \cdot n$, where $n = 1, 2, \dots, 20$;
- d) for channel spacing of 3.5 MHz:
 - lower half of the band: $f_n = f_0 - 148.75 + 3.5 \cdot n$,
 - upper half of the band: $f'_n = f_0 + 5.25 + 3.5 \cdot n$, where $n = 1, 2, \dots, 40$;
- e) for channel spacing of 1.75 MHz:
 - lower half of the band: $f_n = f_0 - 147.875 + 1.75 \cdot n$,
 - upper half of the band: $f'_n = f_0 + 6.125 + 1.75 \cdot n$, where $n = 1, 2, \dots, 80$.

Spectrum occupancy boundaries are shown in Figure A1.1. The duplex separation between Tx/Rx is 154 MHz, other parameters are given in Tables A1.1.1 and A1.1.2.

Figure A1.1
Occupied spectrum: 7125-7425 MHz and 7425-7725 MHz
(all frequencies in MHz)

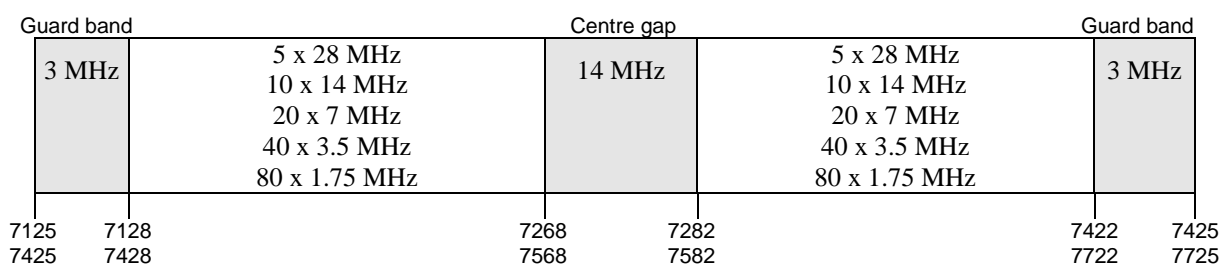

Table A1.1.1: Parameters of the channel arrangement in the 1st band 7125-7425 MHz

XS, MHz	n	f1, MHz	fn, MHz	f1', MHz	fn', MHz	Z1S, MHz	Z2S, MHz	YS, MHz	DS, MHz
28	1...5	7142	7254	7296	7408	17	17	42	154
14	1...10	7135	7261	7289	7415	10	10	28	154
7	1...20	7131.5	7264.5	7285.5	7418.5	6.5	6.5	21	154
3.5	1...40	7129.75	7266.25	7283.75	7420.25	4.75	4.75	17.5	154
1.75	1...80	7128.875	7267.125	7282.875	7421.125	3.875	3.875	15.75	154

Table A1.1.2: Parameters of the channel arrangement in the 2nd band 7425-7725 MHz

XS, MHz	n	f1, MHz	fn, MHz	f1', MHz	fn', MHz	Z1S, MHz	Z2S, MHz	YS, MHz	DS, MHz
28	1...5	7442	7554	7596	7708	17	17	42	154
14	1...10	7435	7561	7589	7715	10	10	28	154
7	1...20	7431.5	7564.5	7585.5	7718.5	6.5	6.5	21	154
3.5	1...40	7429.75	7566.25	7583.75	7720.25	4.75	4.75	17.5	154
1.75	1...80	7428.875	7567.125	7582.875	7721.125	3.875	3.875	15.75	154

Terms used in Tables A1.1.1 and A1.1.2 :

- XS - Separation between centre frequencies of adjacent channels;
- n - Number of duplex channels in the band;
- f1 - Centre frequency of the first channel in the lower part of the band;
- fn - Centre frequency of the final channel in the lower part of the band;
- f1' - Centre frequency of the first channel in the upper part of the band;
- fn' - Centre frequency of the final channel in the upper part of the band;
- Z1S - Separation between the lower band edge and the centre frequency of the first channel;
- Z2S - Separation between centre frequency of the final channel and the upper band edge;
- YS - Separation between centre frequencies of the closest "go" and "return" channels;
- DS - Duplex spacing (fn' – fn).

1.2 CHANNEL ARRANGEMENT IN THE 3rd FREQUENCY BAND 7725-8275 MHz

Administrations wishing to consider a new designation for fixed wireless systems or to restructure their channel arrangement in the frequency band 7725 MHz to 8275 MHz, based on the most usual 28 MHz channel separation over a 3.5 MHz pattern, rather than with the 29.65 MHz of Annex 1.2.2, may consider the following arrangement.

1.2.1 Future channel arrangement of 28 MHz

The RF channel arrangement, in a frequency band of ± 275 MHz across the centre frequency 8 000 MHz for up to eight go and eight return channels, each accommodating high capacity digital systems operating in the 8 GHz band, is as shown in Fig. A1.2.1 and is derived as follows:

Let f_0 be the frequency of the centre of the band of frequencies occupied (MHz),
 f_n be the centre frequency of one RF channel in the lower half of this band (MHz),
 f'_n be the centre frequency of one RF channel in the upper half of this band (MHz),

then the frequencies of the individual channels are expressed by the following relationships:

$$\text{lower half of the band: } f_n = f_0 - 281 + 28 n \quad \text{MHz}$$

$$\text{upper half of the band: } f'_n = f_0 + 2.5 + 28 n \quad \text{MHz}$$

where:

$$n = 1, 2, 3, 4, 5, 6, 7, 8 \text{ or } 9.$$

Figure A1.2.1
RF channel arrangements for digital fixed wireless systems operating in the 7 725-8 275 MHz band
 (all frequencies in MHz)

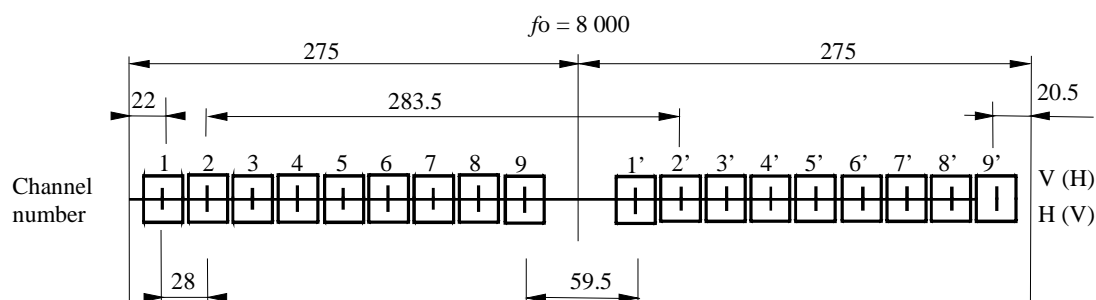

The centre frequency should be:

$$f_0 = 8\,000 \text{ MHz}$$

Narrower channels, 18 channels 14 MHz wide and 36 channels 7 MHz wide, can be obtained by subdivision of the 28 MHz main channels as follows:

14 MHz channels:

$$\text{lower half of the band: } f_n = f_0 - 274 + 14 n \quad \text{MHz}$$

$$\text{upper half of the band: } f'_n = f_0 + 9.5 + 14 n \quad \text{MHz}$$

where:

$$n = 1, 2, \dots, 17 \text{ or } 18.$$

7 MHz channels:

$$\text{lower half of the band: } f_n = f_0 - 270.5 + 7 n \quad \text{MHz}$$

$$\text{upper half of the band: } f'_n = f_0 + 13 + 7 n \quad \text{MHz}$$

where:

$$n = 1, 2, \dots, 35 \text{ or } 36.$$

Table A1.2.1: Parameters of the channel arrangement in the 3rd band 7 725-8 275 MHz

XS, MHz	n	f1, MHz	fn, MHz	f1', MHz	fn', MHz	Z1S, MHz	Z2S, MHz	YS, MHz	DS, MHz
28	1...9	7747	7971	8030.5	8254.5	22	20.5	59.5	283.5
14	1....18	7740	7978	8023.5	8261.5	15	13.5	45.5	283.5
7	1....36	7736.5	7981.5	8020	8265	11.5	10	38.5	283.5

Terms used in Table A1.1 :

- XS - Separation between centre frequencies of adjacent channels;
- n - Number of duplex channels in the band;
- f1 - Centre frequency of the first channel in the lower part of the band;
- fn - Centre frequency of the final channel in the lower part of the band;
- f1' - Centre frequency of the first channel in the upper part of the band;
- fn' - Centre frequency of the final channel in the upper part of the band;
- Z1S - Separation between the lower band edge and the centre frequency of the first channel;
- Z2S - Separation between centre frequency of the final channel and the upper band edge;
- YS - Separation between centre frequencies of the closest “go” and “return” channels;
- DS - Duplex spacing (fn' – fn).

1.2.2 Existing channel arrangement of 29.65 MHz

The RF channel arrangement, in a frequency band ± 275 MHz across the centre frequency 8 000 MHz for up to eight go and eight return channels, each accommodating high capacity digital systems operating in the 8 GHz band, is as shown in Fig. A1.2.1 and is derived as follows:

- Let f_0 be the frequency of the centre of the band of frequencies occupied (MHz),
 f_n be the centre frequency of one RF channel in the lower half of this band (MHz),
 f'_n be the centre frequency of one RF channel in the upper half of this band (MHz),

then the frequencies of the individual channels are expressed by the following relationships:

lower half of the band: $f_n = f_0 - 281.95 + 29.65 n$ MHz

upper half of the band: $f'_n = f_0 + 29.37 + 29.65 n$ MHz

where:

$n = 1, 2, 3, 4, 5, 6, 7$ or 8 .

Figure A1.2.2
RF channel arrangements for digital fixed wireless systems operating in the 7 725-8 275 MHz band
 (all frequencies in MHz)

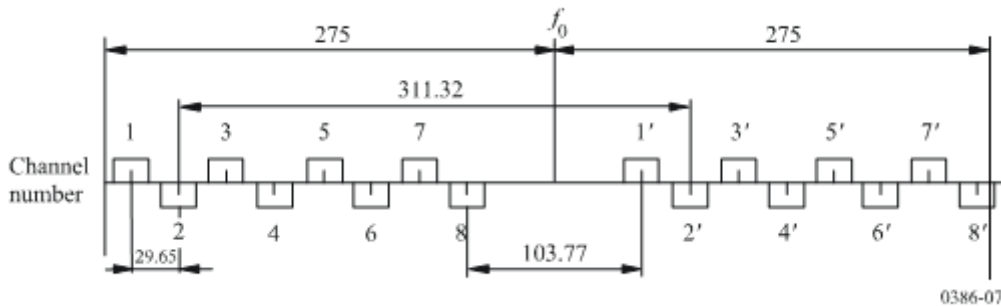

The go and return channels on a given link should preferably use the polarizations shown below:

	<i>Go</i>	<i>Return</i>
H(V)	1 3 5 7	1' 3' 5' 7'
V(H)	2 4 6 8	2' 4' 6' 8'

For digital fixed wireless systems with a co-channel arrangement, the plan as shown in Fig. A1.2.2, should be used.

Figure A1.2.2
Co-channel arrangement for digital fixed wireless systems operating in the 7 725-8 275 MHz band
(all frequencies in MHz)

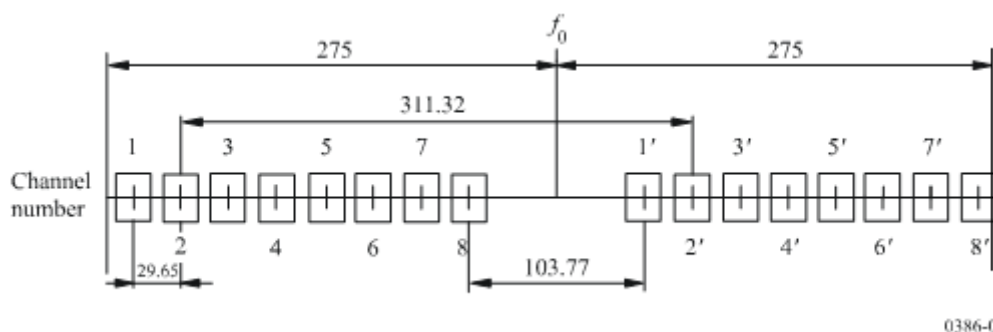

The centre frequency should be:

$$f_0 = 8\,000 \text{ MHz}$$

This value corresponds to the band 7 725-7 975 MHz in the lower half and 8 025-8 275 MHz in the upper half.

Note: When using in the same area channel 8' and channel 1 of the 28 MHz arrangement of the 8 275-8 500 MHz band in Annex 1.3, care should be taken to their separation of 26.43 MHz only, therefore, those 2 channels cannot be used on the same link.

Table A1.2.2: Parameters of the channel arrangement in the 3rd band 7 725-8 275 MHz

XS, MHz	n	f1, MHz	fn, MHz	f1', MHz	fn', MHz	Z1S, MHz	Z2S, MHz	YS, MHz	DS, MHz
29.65	1...8	7747.7	7955.25	8059.02	8266.57	22.7	8.43	103.77	311.32

Terms used in Table A1.2 :

- XS - Separation between centre frequencies of adjacent channels;
- n - Number of duplex channels in the band;
- f1 - Centre frequency of the first channel in the lower part of the band;
- fn - Centre frequency of the final channel in the lower part of the band;
- f1' - Centre frequency of the first channel in the upper part of the band;
- fn' - Centre frequency of the final channel in the upper part of the band;
- Z1S - Separation between the lower band edge and the centre frequency of the first channel;
- Z2S - Separation between centre frequency of the final channel and the upper band edge;
- YS - Separation between centre frequencies of the closest “go” and “return” channels;
- DS - Duplex spacing ($f_n' - f_n$).

1.3 RF CHANNEL ARRANGEMENTS FOR DIGITAL FIXED WIRELESS SYSTEMS OPERATING IN THE 4th FREQUENCY BAND 8 275-8 500 MHz

This Annex describes an RF channel arrangement for digital RF systems operating in the band 8 275-8 500 MHz.

1) The RF channel arrangement, based on interleaved centre frequencies, is shown in Fig. A1.3.1 and is derived as follows:

Let f_0 be the frequency of the centre of the band of frequencies occupied (MHz),
 f_n be the centre frequency of one RF channel in the lower half of the band (MHz),
 f_n' be the centre frequency of a RF channel in the upper half of the band (MHz),

then the frequencies (MHz) of individual channels are expressed by the following relationships:

for systems with channel separation of 28 MHz (interleaved by 14 MHz) and duplex frequency 119 MHz:

$$\text{lower half of the band: } f_n = f_0 - 108.5 + 14 n \text{ MHz}$$

upper half of the band: $f'_n = f_0 + 10.5 + 14 n$ MHz

where:

$$n = 1, 2, 3, 4, 5, \text{ or } 6;$$

for systems with channel separation of 14 MHz (interleaved by 7 MHz) and duplex frequency 126 MHz:

lower half of the band: $f_n = f_0 - 108.5 + 7 n$ MHz

upper half of the band: $f'_n = f_0 + 17.5 + 7 n$ MHz

where:

$$n = 1, 2, 3, \dots 12.$$

The centre frequency f_0 is 8387.5 MHz.

It should be noted that adjacent channel number cannot be used on the same physical link due to channel overlap.

2) When a channel arrangement permitting frequency reuse is preferred, the channels should be derived from the above interleaved arrangement using only odd or even "n" indexes. The actual resulting arrangement is shown in Figure A1.3.2 a) and b)

Figure A.1.3.1
RF channel arrangements for digital fixed wireless systems operating in the 8275-8500 MHz band
(interleaved pattern)
(all frequencies in MHz)

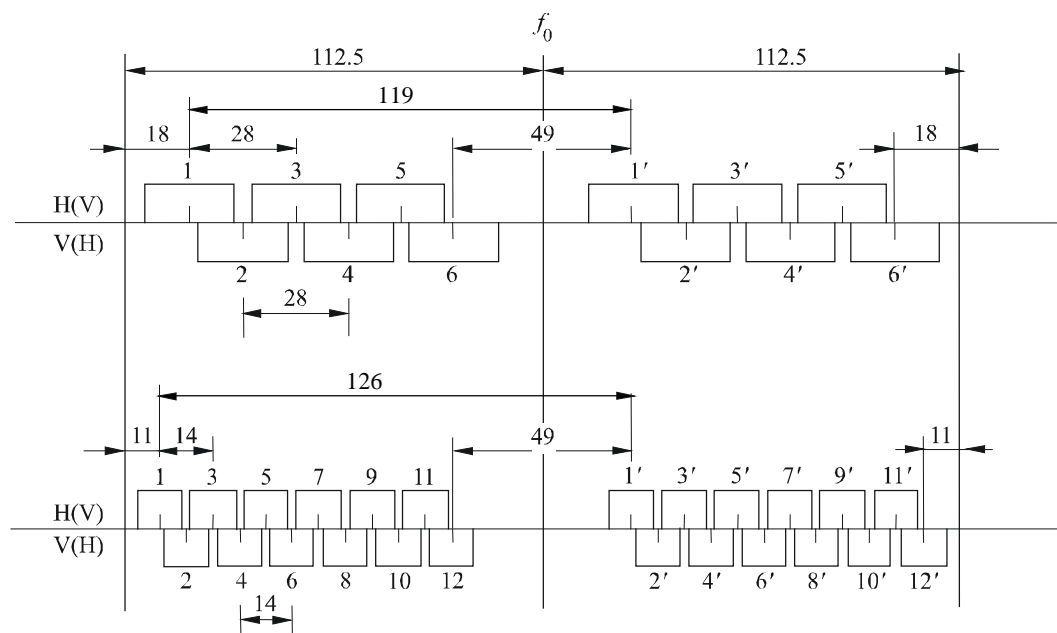
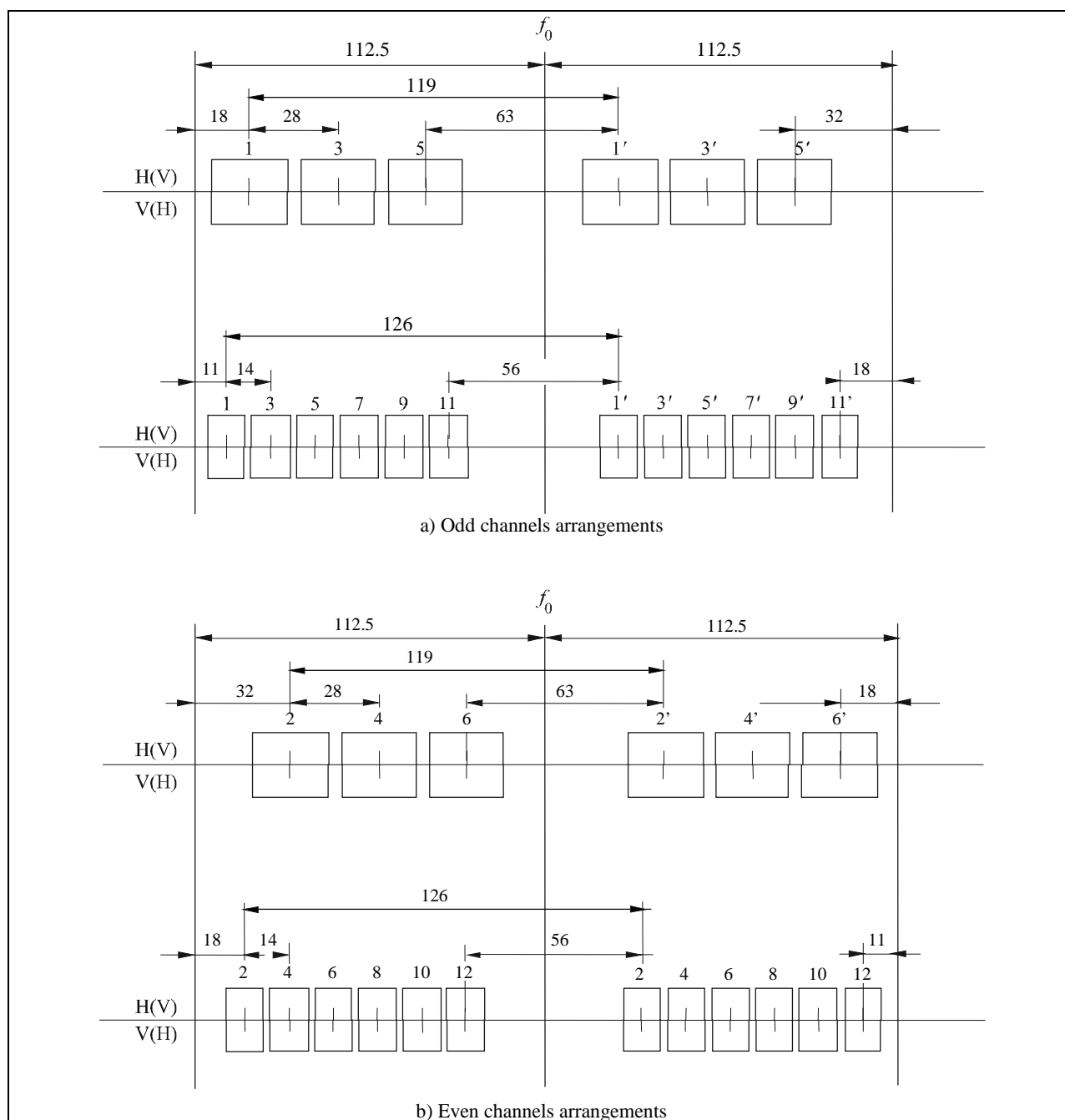

Figure A.1.3.2
RF channel arrangements for digital fixed wireless systems operating in the 8275-8500 MHz band
(frequency reuse pattern)
 (all frequencies in MHz)



Note: When using in the same area channel 1 of the 28 MHz arrangements and channel 8' of the 7725–8275 MHz band in Annex 1.2.2, care should be taken to their separation of 26.43 MHz only, therefore, those 2 channels cannot be used on the same link.

Table A1.3: Parameters of the channel arrangement in the 4th band 8 275-8 500 MHz

XS, MHz	n	f1, MHz	fn, MHz	f1', MHz	fn', MHz	Z1S, MHz	Z2S, MHz	YS, MHz	DS, MHz
28	1...6	8293	8363	8412	8482	18	18	49	119
14	1...12	8286	8363	8412	8489	11	11	49	126

Terms used in Table A1.3 :

- XS - Separation between centre frequencies of adjacent channels;
- n - Number of duplex channels in the band;
- f1 - Centre frequency of the first channel in the lower part of the band;
- fn - Centre frequency of the final channel in the lower part of the band;
- f1' - Centre frequency of the first channel in the upper part of the band;
- fn' - Centre frequency of the final channel in the upper part of the band;
- Z1S - Separation between the lower band edge and the centre frequency of the first channel;
- Z2S - Separation between centre frequency of the final channel and the upper band edge;
- YS - Separation between centre frequencies of the closest “go” and “return” channels;
- DS - Duplex spacing ($fn' - fn$).

Annex 2
Second optional set of channel arrangements for covering the whole range 7125-8500 MHz

The frequency range is covered by three contiguous arrangements according the following generic scheme:

Frequency ranges (MHz)		
7125 - 7425	7425 - 7900	7900 - 8500
1st band Arrangement	2nd band Arrangement	3rd band Arrangement

2.1 PREFERRED CHANNEL ARRANGEMENTS IN THE 1st FREQUENCY BAND 7125-7425 MHz

This frequency band is covered by the same arrangement in Annex 1.1.1.

2.2 RF CHANNEL ARRANGEMENT IN THE 2ND BAND 7 425-7900 MHz WITH A CHANNEL SPACING UP TO 28 MHz

a) The RF channel arrangement suitable for digital FWSs with a channel spacing up to 28 MHz, and makes provision for eight 28 MHz channels.

The radio-frequency channel arrangement is shown in Fig. A2.2 and is derived as follows:

Let f_0 be the frequency of the centre of the band of frequencies occupied (7 662.5 MHz),

f_n be the centre frequency of one RF channel in the lower half of the band (MHz),

f'_n be the centre frequency of one RF channel in the upper half of the band (MHz),

then the frequencies (MHz) of individual 28 MHz channels are expressed by the following relationships:

$$f_n = f_0 - 248.5 + 28 n$$

$$f'_n = f_0 - 3.5 + 28 n$$

where:

$$n = 1 \text{ to } 8.$$

Note 1: The first five channels with a spacing of 28 MHz in the lower sub-band of the above channel arrangement align with those in Annex 1.2, covering the 7 425-7 725 MHz band.

b) The eight channels with a spacing of 28 MHz can be subdivided to provide 16 channels with a spacing of 14 MHz or 32 channels with a spacing of 7 MHz.

Figure A2.2
RF channel arrangements for digital fixed wireless systems operating in the 7 425-7900 MHz band
(all frequencies in MHz)
RF channel arrangement for digital systems operating in the band 7 425-7 900 MHz
(All frequencies in MHz)

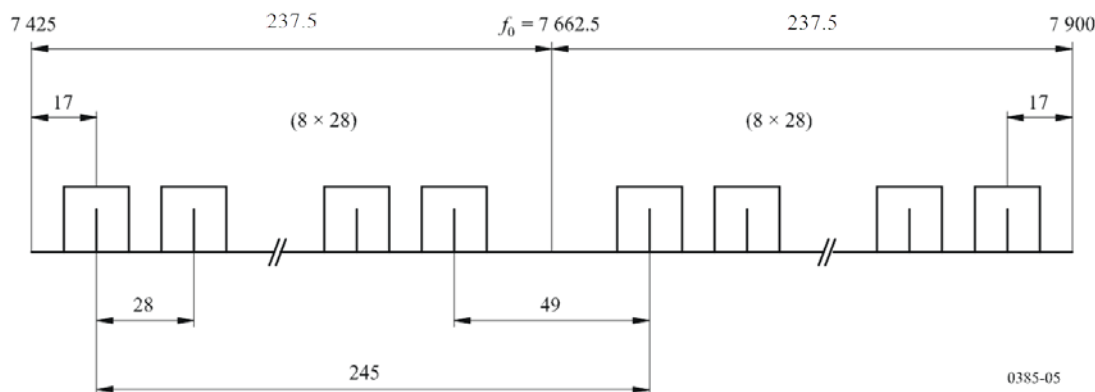

The frequencies (MHz) of individual channels are expressed by the following relationships:

for 14 MHz channels:

$$f_n = f_0 - 241.5 + 14 n$$

$$f'_n = f_0 + 3.5 + 14 n$$

where:

$$n = 1 \text{ to } 16$$

for 7 MHz channels:

$$f_n = f_0 - 238 + 7 n$$

$$f'_n = f_0 + 7 + 7 n$$

where:

$$n = 1 \text{ to } 32.$$

The duplex separation between Tx/Rx is 245 MHz, other parameters are given in Table A2.1

Table A2.2: Parameters of the channel arrangement in the band

XS, MHz	n	f1, MHz	fn, MHz	f1', MHz	fn', MHz	Z1S, MHz	Z2S, MHz	YS, MHz	DS, MHz
28	1...8	7442	7638	7687	7883	17	17	49	245
14	1...16	7435	7645	7680	7890	10	10	35	245
7	1...32	7431.5	7648.5	7676.5	7893.5	6.5	6.5	28	245

Note 1: The first five channels with a spacing of 28 MHz in the lower sub-band of the above channel arrangement are aligned with those in Annex 1.2, covering the 7 425-7 725 MHz band.

2.3 PREFERRED CHANNEL ARRANGEMENT IN THE 3rd FREQUENCY BAND 7900-8500 MHz

Let:

- $f_0 = 8200$ MHz – be the centre frequency of the band 7900-8500 MHz,
- f_n – be the centre frequency of a n -th radio-frequency channel in the lower half of the band (MHz),
- f'_n – be the centre frequency of a n -th radio-frequency channel in the upper half of the band (MHz).

Then the centre frequencies (MHz) of individual channels are expressed by the following relationships:

a) for channel spacing of 28 MHz:

$$\begin{aligned} \text{lower half of the band:} & f_n = f_0 - 309 + 28 \cdot n, \\ \text{upper half of the band:} & f'_n = f_0 + 1 + 28 \cdot n, \end{aligned} \quad \text{where } n = 1, 2, \dots, 10;$$

b) for channel spacing of 14 MHz:

$$\begin{aligned} \text{lower half of the band:} & f_n = f_0 - 302 + 14 \cdot n, \\ \text{upper half of the band:} & f'_n = f_0 + 8 + 14 \cdot n, \end{aligned} \quad \text{where } n = 1, 2, \dots, 20;$$

c) for channel spacing of 7 MHz:

$$\begin{aligned} \text{lower half of the band:} & f_n = f_0 - 298.5 + 7 \cdot n, \\ \text{upper half of the band:} & f'_n = f_0 + 11.5 + 7 \cdot n, \end{aligned} \quad \text{where } n = 1, 2, \dots, 40;$$

d) for channel spacing of 3.5 MHz:

$$\begin{aligned} \text{lower half of the band:} & f_n = f_0 - 296.75 + 3.5 \cdot n, \\ \text{upper half of the band:} & f'_n = f_0 + 13.25 + 3.5 \cdot n, \end{aligned} \quad \text{where } n = 1, 2, \dots, 80;$$

e) for channel spacing of 1.75 MHz:

$$\begin{aligned} \text{lower half of the band:} & f_n = f_0 - 295.875 + 1.75 \cdot n, \\ \text{upper half of the band:} & f'_n = f_0 + 14.125 + 1.75 \cdot n, \end{aligned} \quad \text{where } n = 1, 2, \dots, 160.$$

Spectrum occupancy boundaries are shown in Fig. A2.3. The duplex separation between Tx/Rx is 310 MHz, other parameters are given in Table A2.3.

Figure A2.3
Occupied spectrum: 7900-8500 MHz
(all frequencies in MHz)

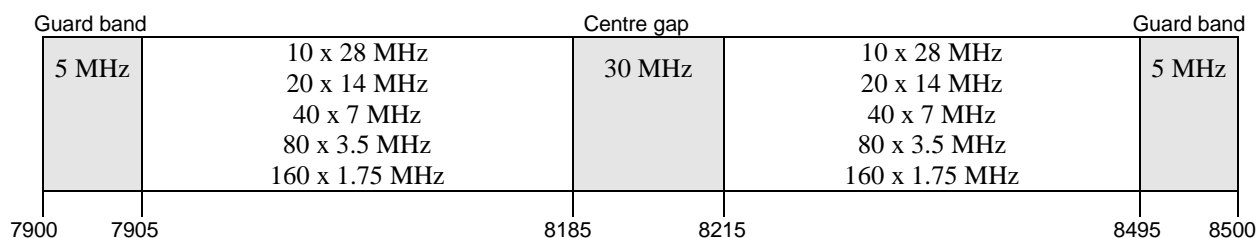

Table A2.3: Parameters of the channel arrangement in the band 7900-8500 MHz

XS, MHz	n	f1, MHz	fn, MHz	f1', MHz	fn', MHz	Z1S, MHz	Z2S, MHz	YS, MHz	DS, MHz
28	1...10	7919	8171	8229	8481	19	19	58	310
14	1...20	7912	8178	8222	8488	12	12	44	310
7	1...40	7908.5	8181.5	8218.5	8491.5	8.5	8.5	37	310
3.5	1...80	7906.75	8183.25	8216.75	8493.25	6.75	6.75	33.5	310
1.75	1...160	7905.875	8184.125	8215.875	8494.125	5.875	5.875	31.75	310

Annex 3

CHANNEL IDENTIFIERS FOR DERIVATIVE CHANNELS

The derivative 56 MHz (or 59.3 MHz where appropriate) channels (ref. Recommends 3) can be identified by using the following numbering:

1) For the band 7125 MHz – 7425 MHz (Annexes 1.1.1 and 2.1):

$$\begin{aligned} f_n &= (f_0 - 147 + 28 \cdot n), \text{ MHz} \\ f_n' &= (f_0 + 7 + 28 \cdot n), \text{ MHz} \\ n &= 1, 2, \dots, 4 \\ f_0 &= 7275 \text{ MHz} \end{aligned}$$

2) For the band 7425 MHz – 7725 MHz (Annex 1.1.2):

$$\begin{aligned} f_n &= (f_0 - 147 + 28 \cdot n), \text{ MHz} \\ f_n' &= (f_0 + 7 + 28 \cdot n), \text{ MHz} \\ n &= 1, 2, \dots, 4 \\ f_0 &= 7575 \text{ MHz} \end{aligned}$$

3) For the band 7425 – 7900 MHz (Annex 2.2):

$$\begin{aligned} f_n &= (f_0 - 234.5 + 28 \cdot n), \text{ MHz} \\ f_n' &= (f_0 + 10.5 + 28 \cdot n), \text{ MHz} \\ n &= 1, 2, \dots, 7 \\ f_0 &= 7662.5 \text{ MHz} \end{aligned}$$

4) For the band 7900 MHz – 8500 MHz (Annex 2.3):

$$\begin{aligned} f_n &= (f_0 - 295 + 28 \cdot n), \text{ MHz} \\ f_n' &= (f_0 + 15 + 28 \cdot n), \text{ MHz} \\ n &= 1, 2, \dots, 9 \\ f_0 &= 8200 \text{ MHz} \end{aligned}$$

5) For the band 7725 MHz – 8275 MHz (Annex 1.2.1):

$$\begin{aligned} f_n &= (f_0 - 267 + 28 \cdot n), \text{ MHz} \\ f_n' &= (f_0 + 16.5 + 28 \cdot n), \text{ MHz} \\ n &= 1, 2, \dots, 8 \\ f_0 &= 8000 \text{ MHz} \end{aligned}$$

Note: The numbering is just for identification of the channelling. It should be noted, that adjacent channel numbers cannot be used on the same physical link due to channel overlap. See diagram below for channel arrangement example.

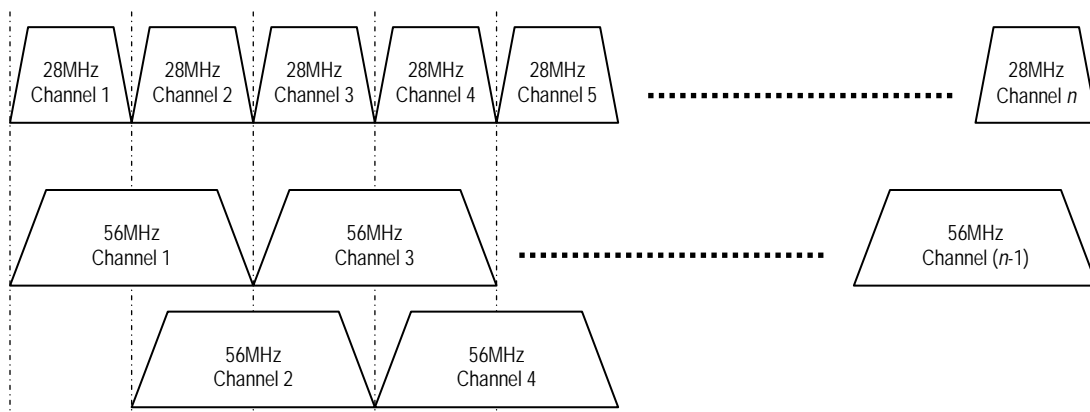

6) For the band 7725 MHz – 8275 MHz (Annex 1.2.2):

$$f_n = (f_0 - 267.125 + 29.65 \cdot n), \text{ MHz}$$

$$f_n' = (f_0 + 44.195 + 29.65 \cdot n), \text{ MHz}$$

$$n = 1, 2, \dots, 7$$

$$f_0 = 8000 \text{ MHz}$$

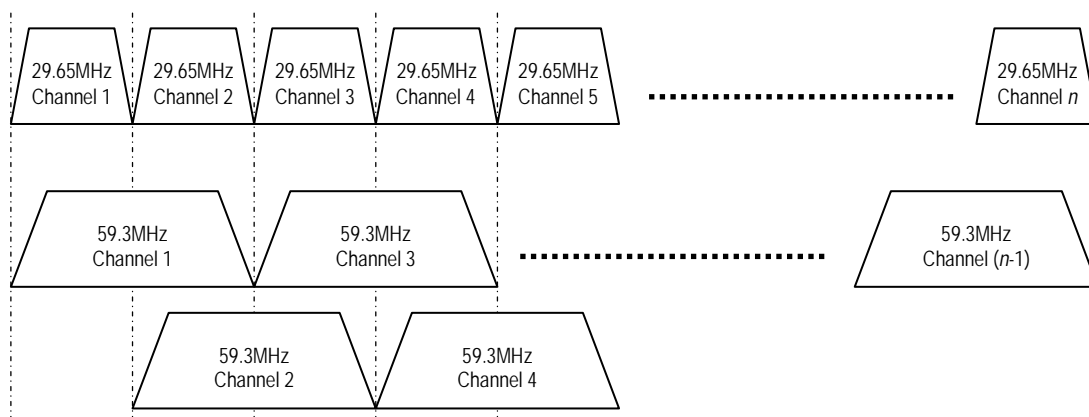

Note: The numbering is just for identification of the channelling. It should be noted, that adjacent channel numbers cannot be used on the same physical link due to channel overlap. See diagram above for channel arrangement example.

7) For the band 8275 MHz – 8500 MHz (Annex 1.3):

$$f_n = (f_0 - 94.5 + 14 \cdot n), \text{ MHz}$$

$$f_n' = (f_0 + 24.5 + 14 \cdot n), \text{ MHz}$$

$$n = 1, 2, \dots, 4$$

$$f_0 = 8387.5 \text{ MHz}$$

Note: The numbering is just for identification of the channelling. It should be noted, that no other channel number can be used on the same physical link due to channel overlap. See diagram below for channel arrangement example.

